

# **Installation and Maintenance manual**

LED Module

[Models for indoor use]

**LED-E012i**

**LED-E015i**

**LED-E018i**

**LED-E025i**

MODELS: LED-E012i, LED-E015i, LED-E018i, LED-E025i

# Table of Contents

---

<b>Important Information .....</b>	<b>English-1</b>
<b>About the LED lamps .....</b>	<b>English-4</b>
Lamp break-in .....	English-4
<b>Contents.....</b>	<b>English-5</b>
<b>Related Items for Installation .....</b>	<b>English-6</b>
<b>Parts Name .....</b>	<b>English-7</b>
<b>Installation Example .....</b>	<b>English-8</b>
<b>Screen Configuration.....</b>	<b>English-18</b>
<b>Image Setting .....</b>	<b>English-27</b>
<b>Maintenance.....</b>	<b>English-29</b>
<b>Troubleshooting .....</b>	<b>English-32</b>
<b>Specifications .....</b>	<b>English-38</b>
<b>Diagram .....</b>	<b>English-39</b>

# Important Information



---

## Safety Precautions and Maintenance



FOR OPTIMUM PERFORMANCE, PLEASE NOTE  
THE FOLLOWING WHEN SETTING UP AND  
USING THE LED DISPLAY SYSTEM:

### About the Symbols

To ensure safe and proper use of the product, this manual uses a number of symbols to prevent injury to you and others as well as damage to property. The symbols and their meanings are described below. Be sure to understand them thoroughly before reading this manual.















 <b>WARNING</b>	<b>Failing to heed this symbol and handling the product incorrectly could result in accidents leading to major injury or death.</b>
 <b>CAUTION</b>	<b>Failing to heed this symbol and handling the product incorrectly could result in personal injury or damage to surrounding property.</b>

### Examples of symbols

	<b>⚠ Indicates a warning or caution.</b> <b>This symbol indicates you should be careful of electric shocks.</b>
	<b>⊘ Indicates a prohibited action.</b> <b>This symbol indicates something that must be prohibited.</b>
	<b>● Indicates a mandatory action.</b> <b>This symbol indicates that the power cord should be unplugged from the power outlet.</b>

- Be sure to read the following before using the product to use it correctly and safely.

## **WARNING**

-  Do not apply vibrations or shocks to the product.
-  Do not install the product to unstable locations or locations subject to vibrations.
-  Always ask a technician to perform the installation.
-  Do not connect the cables with wet hands. Otherwise, it may cause an injury or an electrical shock.
-  Do not repair or modify the product yourself. Otherwise, it may cause an injury, a fire or an electrical shock.
-  In case of thunder, do not touch the power cord. Otherwise, it may cause an electrical shock.
-  Connect the product to the correct voltage. If the product is connected to a voltage other than the specified voltage, it may lead to a fire or an electrical shock.
-  In case of a malfunction (nothing is displayed on the screen, etc.) or if smoke, abnormal heat, or a strange sound or odor is generated, turn the power off and immediately ask a technician or your retailer for repair.
-  Install the product so that the vents are not obstructed.
-  Make sure there are enough people available to ensure safety (at least two people) when installing or moving the product. Otherwise, it may lead to an injury.
-  Be sure to ground the product. If the product is not grounded, there is a risk of electrical shock in case a malfunction occurs.
-  In case foreign matter has entered into the product, immediately disconnect the power supply and stop using the product.
-  After the installation, if a problem such as loose screws occurs, immediately ask a technician or your retailer for repair.
-  Do not put objects into the product. Otherwise, it may cause a fire or an electrical shock.
-  In case the product is in contact with water or another liquid, immediately disconnect the power supply and stop using the product. If you continue using the product in that state, it may lead to a malfunction, a fire, or an electrical shock.

## CAUTION

 Do not damage the power cord. Do not put heavy objects on it, place it near heaters, pull it with excessive strength, or apply a strong force on it while it is bent. A damaged power cord may cause a fire or an electrical shock.

 Do not install the product in narrow places where heat tends to build up.

 Do not use the product in an environment with low heat dissipation. Otherwise, it may cause a malfunction.

 The RJ-45 port of the product is for use with the product only. Do not connect it to a network. Connecting this port to a network that may receive over-voltage current may cause damage to the product or an electrical shock.

 Do not use the product in a vehicle or another means of transportation.

Do not use or store the product in the following places.

- Near heaters
- Places with lots of humidity or dust, or places subject to oily smoke
- Places where water or oil may splash
- Places with lots of corrosive gases, such as near hot springs
- Places where the product may freeze
- Do not place the product on its side, face down, or upside down.
- Places with lots of vibrations



If you will not be using the product for a long time, disconnect it from the power distributor for safety purposes.



Disconnect the power supply when performing the maintenance.



Install the product in accordance with the local laws and regulations.



Do not place the product under direct sunlight or near heaters.



This product is designed to be used indoors. Do not use it outdoors. Otherwise, it may cause a malfunction.

This product can only be serviced in the country where it was purchased.

# About the LED lamps



LED lamps are sensitive to static electricity and surge voltage, which may damage their components and decrease their reliability. Take measures against static electricity during the installation. Do not touch the LED display areas.

The LED lamps may absorb and hold moisture during the LED module installation or if not used for a long time. Therefore, in such cases, the brightness must be increased gradually during a break-in period before setting the normal brightness.



If the LED lamps are lit with 100% brightness while moisture is retained, the temperature will rise very quickly and the water inside the lamps will evaporate and expand. This will cause the encapsulating resin to expand, which may lead to separation of the boundary surface inside the LED lamps. This separation can cause the LED lamps not to light up properly.

## Lamp break-in

Configure the brightness settings as shown below with a video displayed on the LED module. After a break-in period of approximately 3 hours, the LED module can be used under normal conditions.

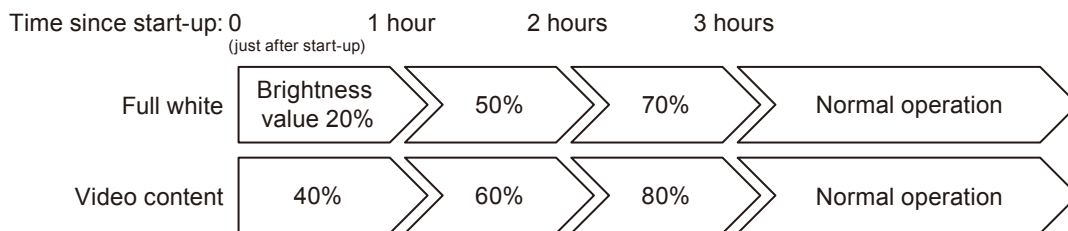

# Contents

---

The supplied parts are as follows.

In case one of these parts is missing or damaged, contact the retailer.

[Cabinet]

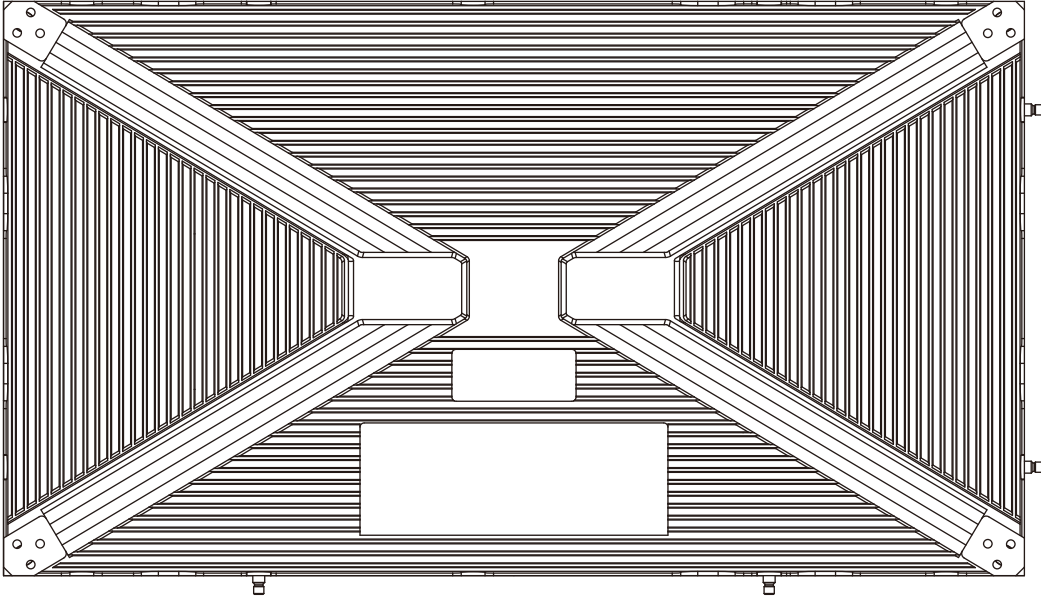

[Pixel card]

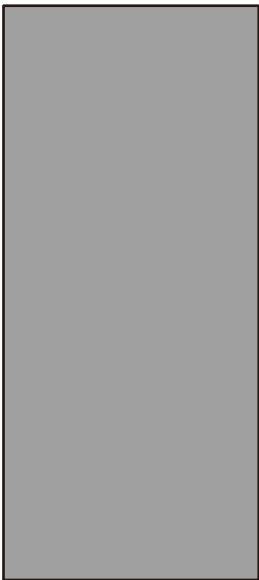

4 cards per cabinet

# Related Items for Installation

---

The items required when installing the system are shown below.  
Contact your retailer for more details.

[Power cord]

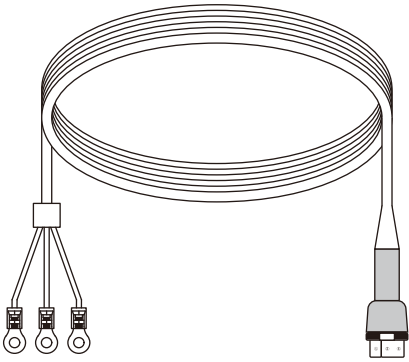

To connect the LED module to the power distributor

[LAN cable]

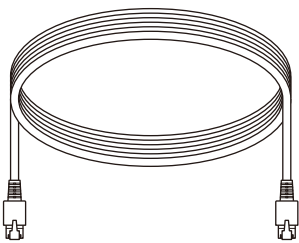

To connect the LED module to the LED controller

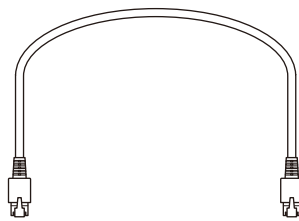

To connect two LED modules together

[Installation bracket]

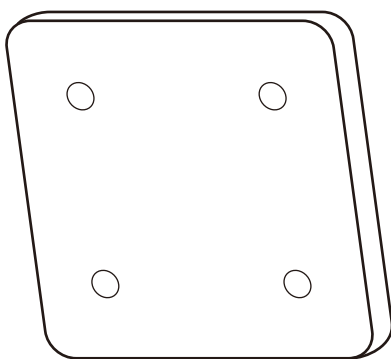

[Connection screw for Installation bracket]

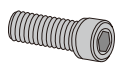

[Connection screw for LED modules]



[Cabinet alignment bracket]

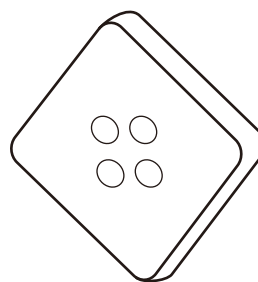

[USB drive]

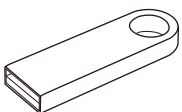

Contains the data, the user's manual, and the control software for the product you have purchased.



# Parts Name

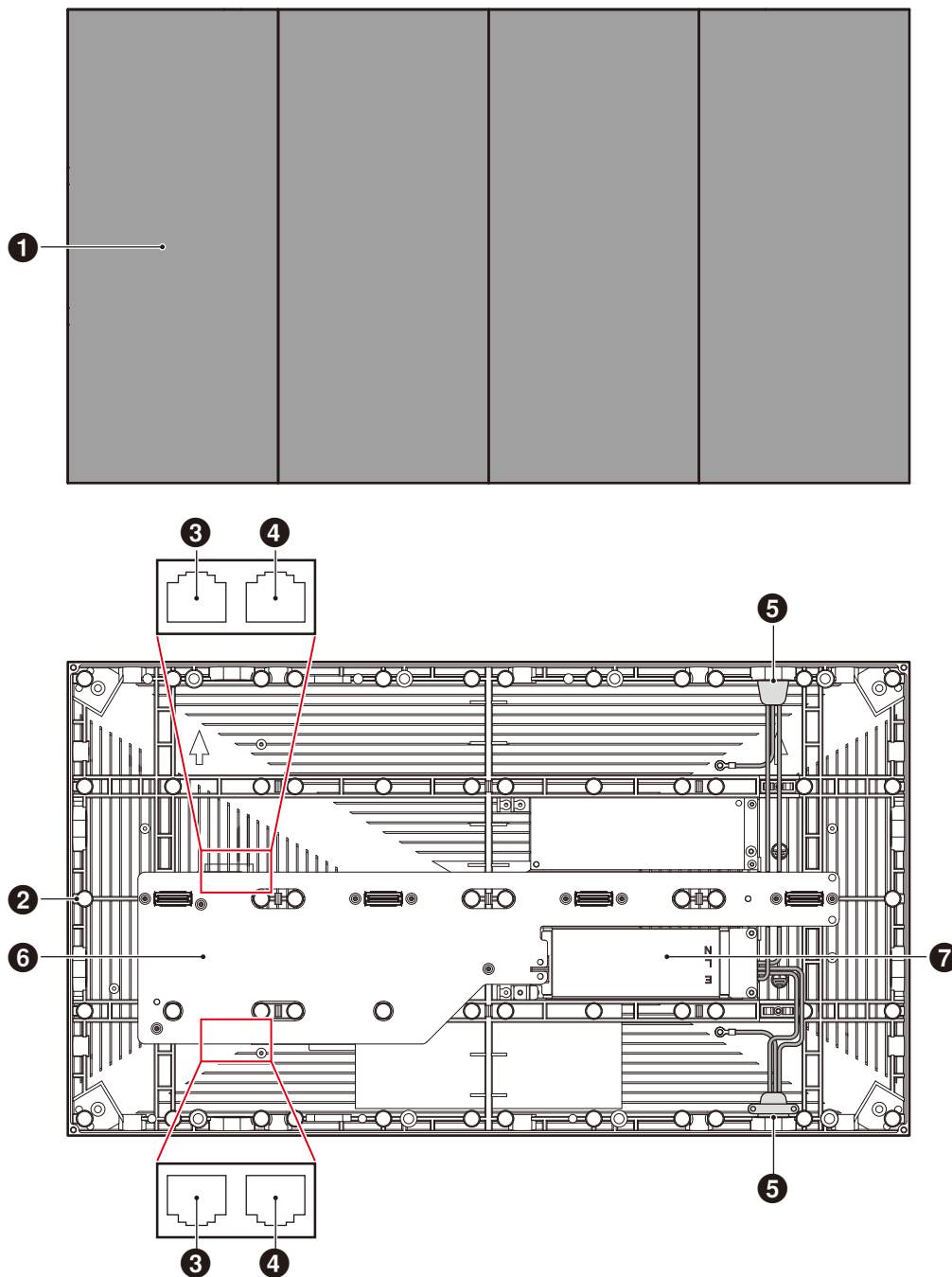

- ① Pixel card
- ② Cabinet
- ③ LAN cable input/output
- ④ LAN cable input (not used with this product)
- ⑤ Power cord input/output
- ⑥ Hub board
- ⑦ Power unit

# Installation Example

Before the installation, be sure to review the following safety precautions to ensure proper and safe installation.

**⚠ CAUTION**

- Ask a technician to perform the installation.
- Make sure the product is moved and installed by enough people to ensure safety.
- Make sure that the beams or the other structures to which the product is installed have enough strength to support the weight of the product, and make sure that the product is securely fixed.
- Do not install directly the product to a surface that has not enough strength.
- When installing the product in a narrow place (in a wall, etc.), leave gaps around the LED screens as shown in the figure below to prevent an increase in the temperature. The figure below is only an example. Pay particular attention to the installation environment (heat from the external environment, direct sunlight, heat generated by the number of displays) in order to facilitate cooling of the LED modules. If cooling is not sufficient, take measures, such as increasing the distance from the walls or installing a forced-air cooling system. Ask a technician or your retailer for more details.
- The power cords, LAN cables, and installation materials (hanging bars, etc.) are sold separately.

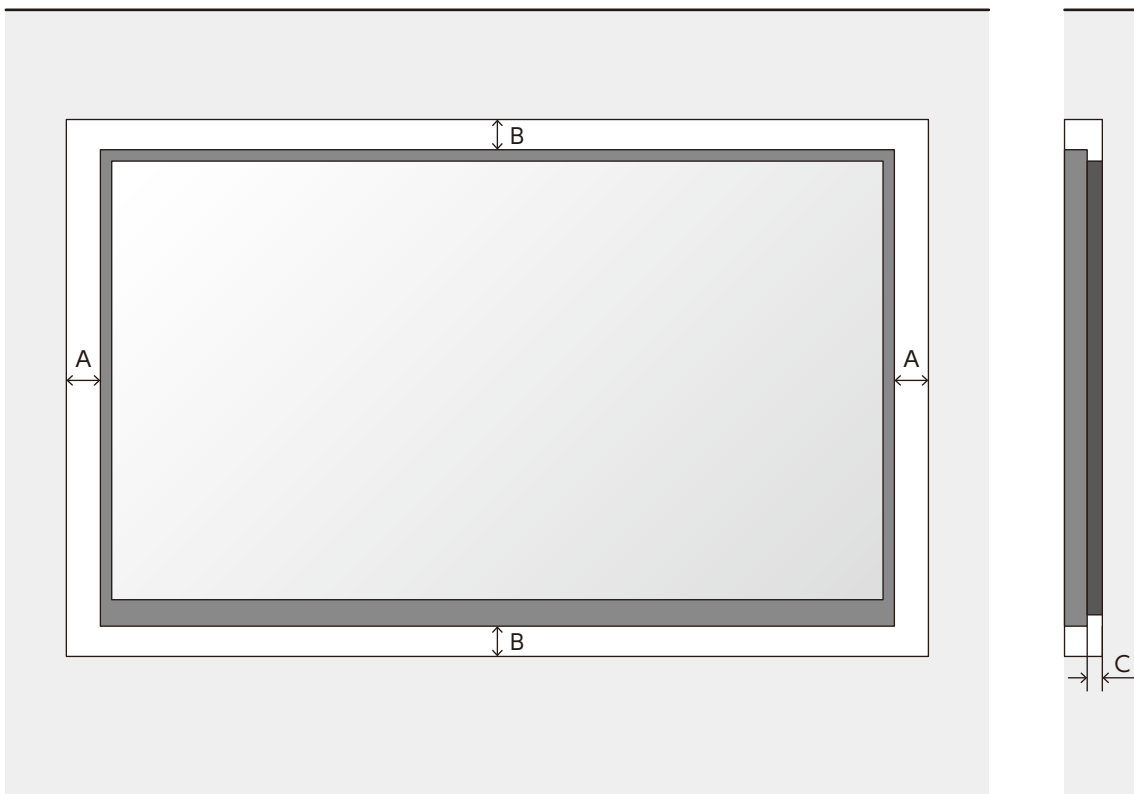

A	B	C
min distance to sides	min. distance to top and bottom	Distance between wall and system
60 mm	60 mm	30 mm

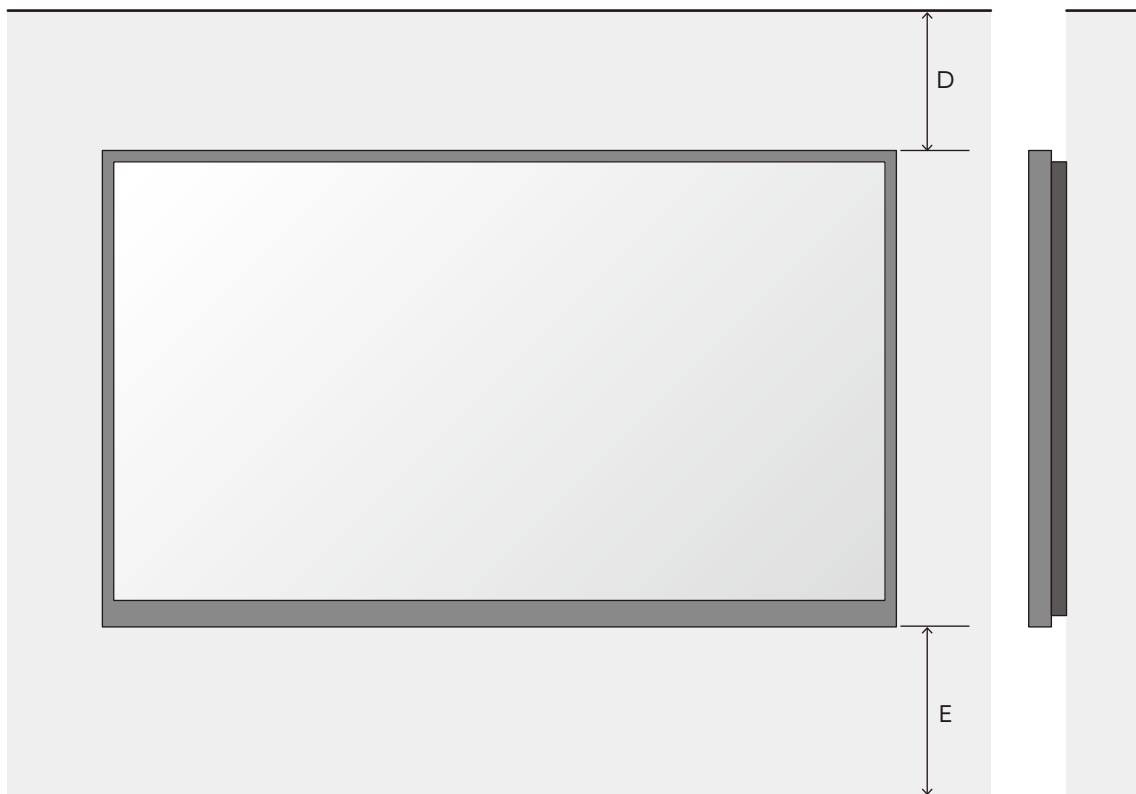

D	E
min. distance to ceiling	min. distance to floor
500 mm	700 mm

A recommended example of installation when using the brackets is shown below. Ask a technician or your retailer for the installation procedure when not using the brackets.

Install the brackets to the frame as shown in the figure below.

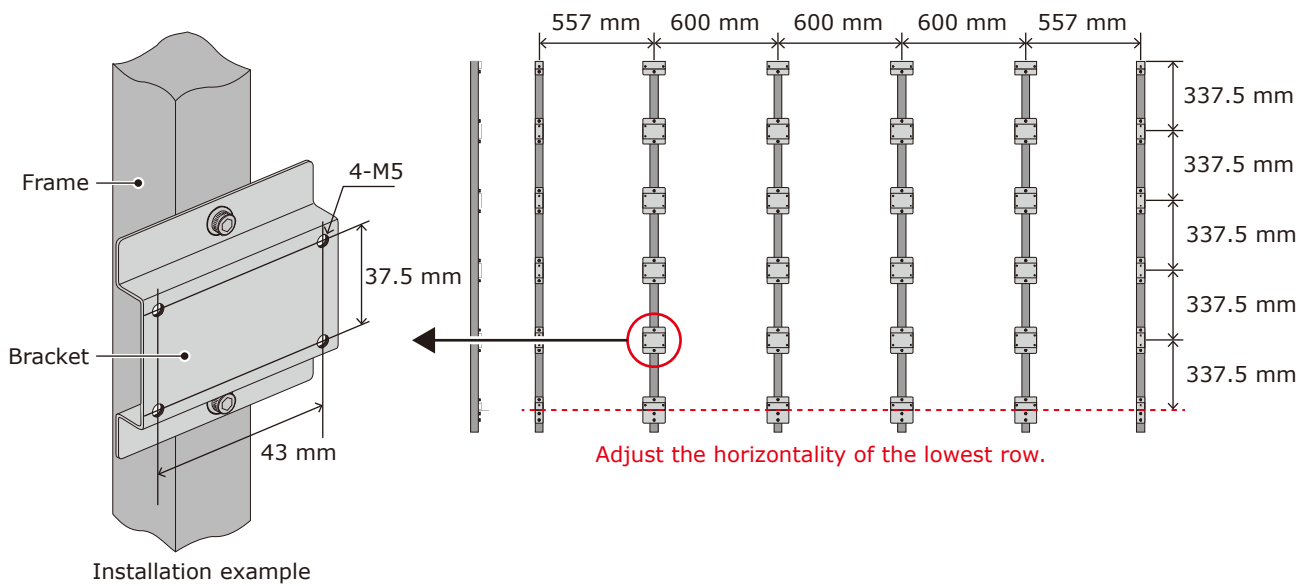

Install the LED cabinets starting from the bottom row.

First, secure temporarily the cabinets to the bracket using screws.

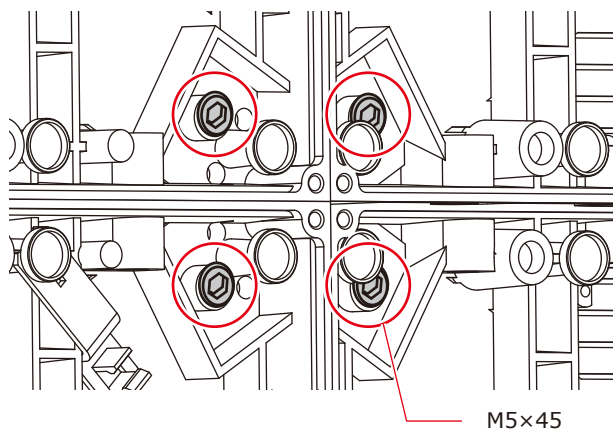

Then, secure the LED cabinets together using connection screws for LED modules. Do not tighten the screws completely.

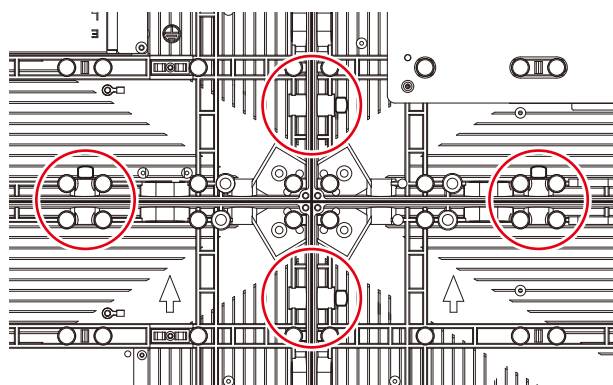

Align the surfaces of the cabinets using the cabinet alignment bracket.

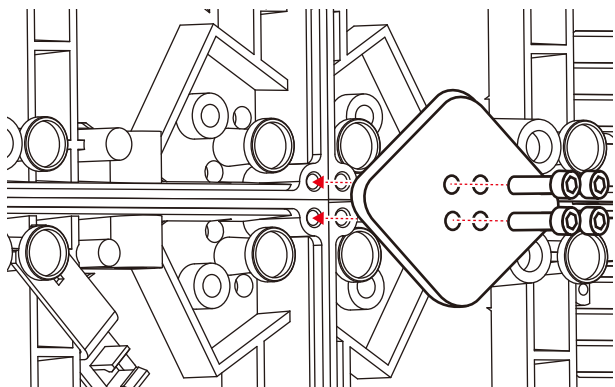

When the cabinets' surfaces are aligned, completely tighten the screws securing the cabinets to the brackets and the screws securing the cabinets together.  
Remove the cabinet alignment bracket after the screws have been tightened.

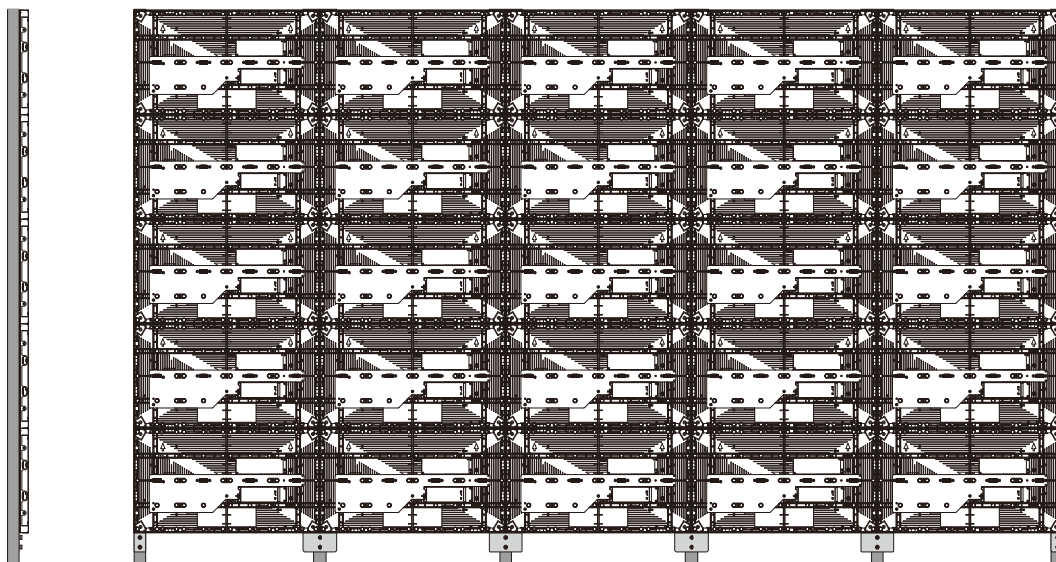

## 1. Wiring

### (1) Maximum number of signal connections

The maximum number of connections per LAN cable is shown below.

Product name	Maximum number of connections
LED-E012i	5 modules
LED-E015i	7 modules
LED-E018i	10 modules
LED-E025i	20 modules

### CAUTION

The maximum number of connections may differ depending on the connected LED controller. Therefore, check the specifications of the LED controller you are using. Ask a technician or your retailer for more details.

### (2) Maximum number of power connections

### CAUTION

Exceeding the maximum capacity may generate smoke or cause a fire. Check the voltage used and do not exceed the connection limits shown below.

Product name	100 - 120 V AC	200 - 240 V AC
LED-E012i	10 modules	20 modules
LED-E015i	10 modules	20 modules
LED-E018i	10 modules	20 modules
LED-E025i	10 modules	20 modules

### (3) Power cord connection

Connect the power cords to the LED modules on the first row.

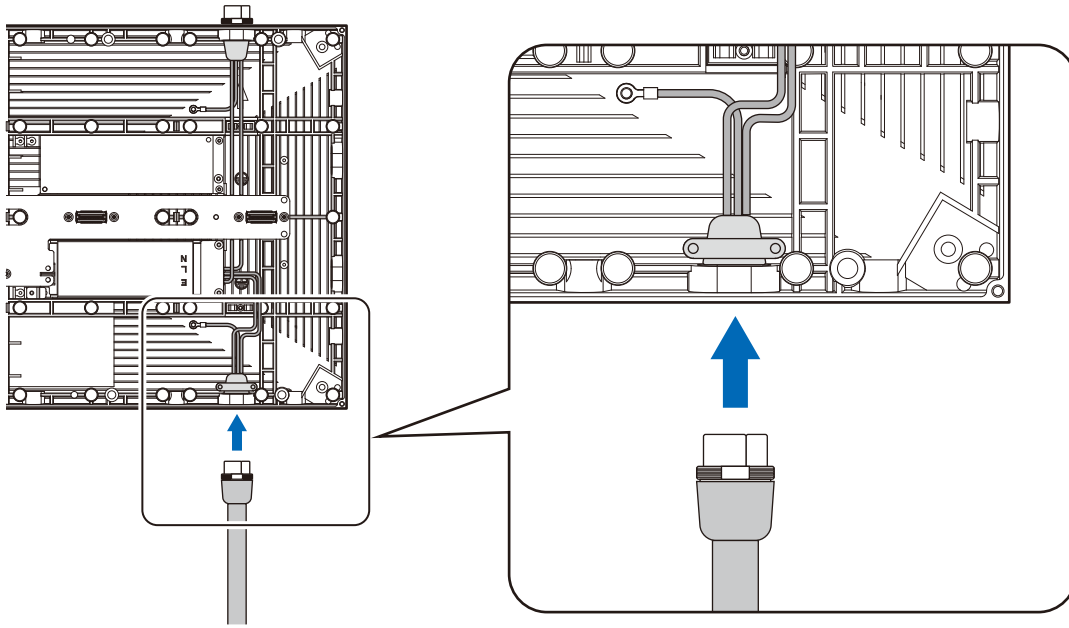

The power cord must be securely plugged.

Connect the power cords between the LED modules.

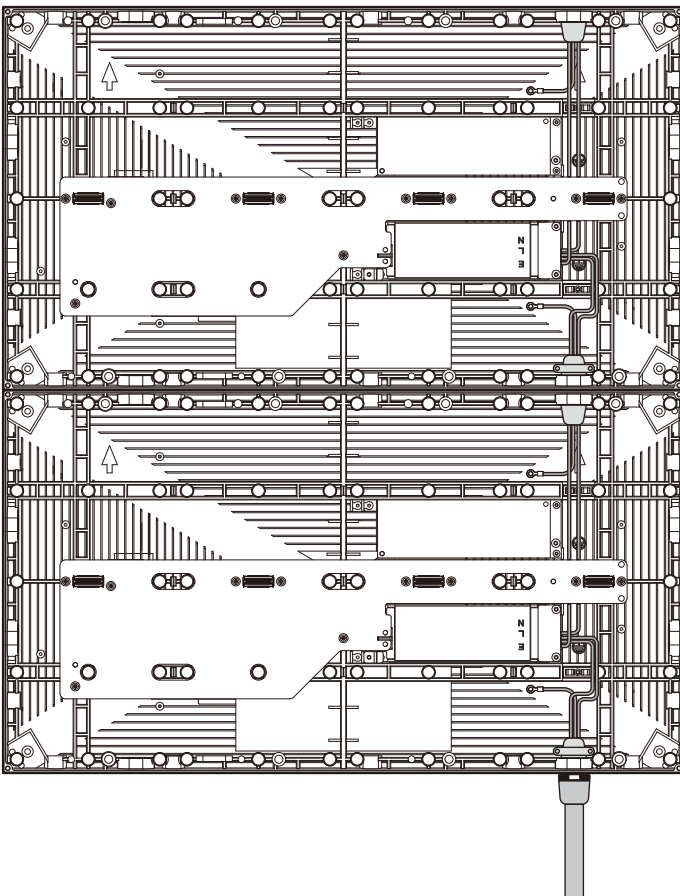

#### (4) LAN cable connection

Connect the LAN cables for the signal between the LED modules. Use the through holes to pass the cables between the modules.

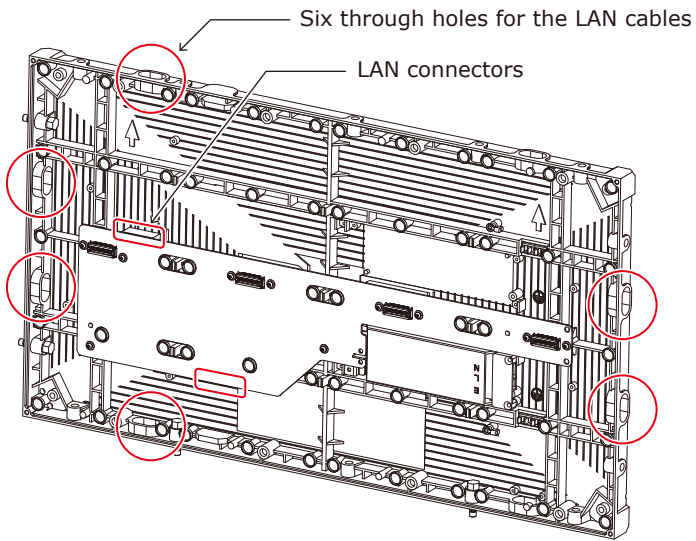

#### [Connection example 1] Connecting from bottom to top using multiple ports

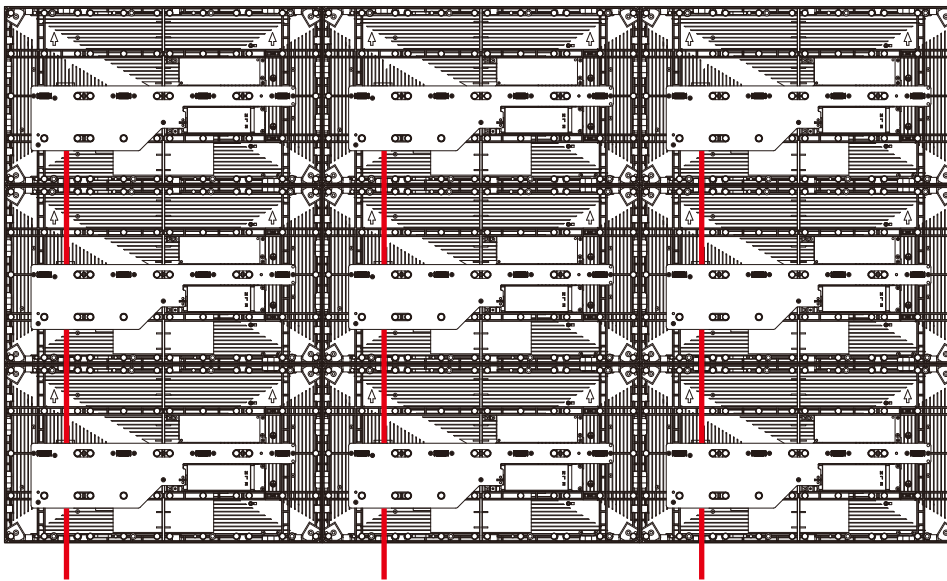



**[Connection example 2]** Connecting all the LED modules using a single LAN cable

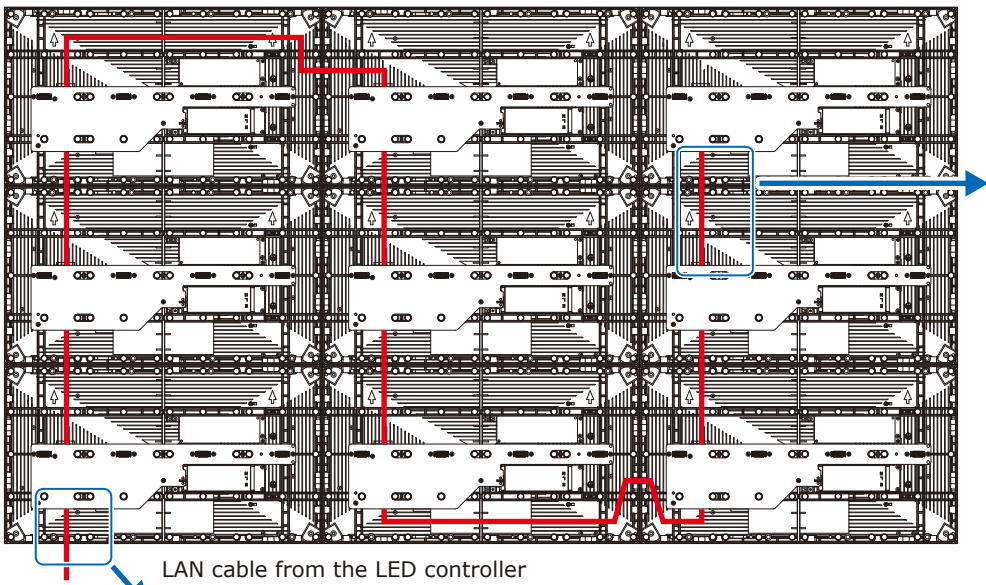

LAN cable from the LED controller

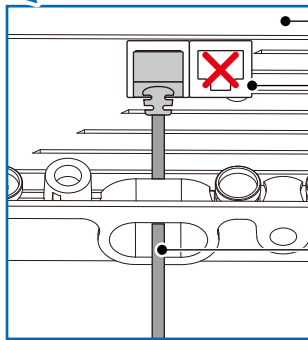

Hub board

Connect the cable to the LAN connector on the left.  
Do not use the LAN connector on the right.

Insert the LAN cable into the through hole and connect it to the LAN connector on the left.

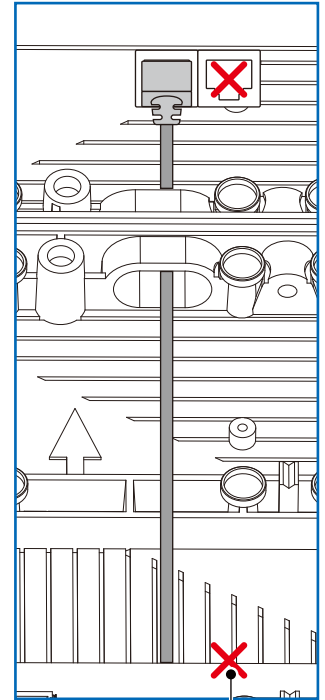

## 2. Installing the pixel card

### CAUTION

- The pixel cards contain powerful magnets. If magnetic cards come close to the pixel cards, the data contained within may be damaged. Therefore, do not carry any magnetic card when installing the pixel cards.
- When installing the pixel cards, pay attention not to damage them against the pixel cards already installed or other objects. Otherwise, the video may not be displayed properly.
- Take measures against static electricity when installing the pixel card. Do not touch the LED display areas and the back of the pixel card.
- Check that the power supply to the LED modules is cut before starting the work.

Install the pixel card using the maintenance tool.

Pull the trigger of the handle to activate the suction function. Release the trigger to stop the suction function.

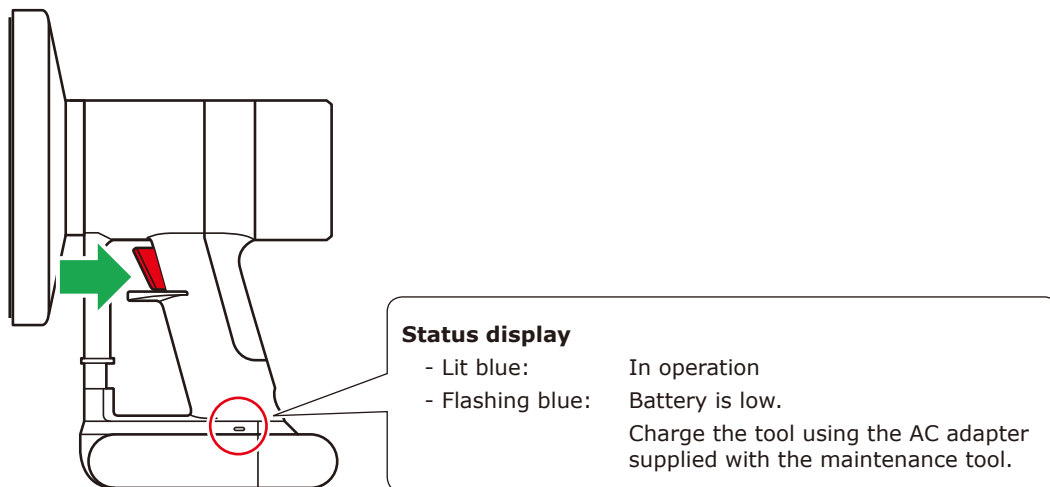

### CAUTION

Check that the battery of the tool is fully charged before starting the work. The pixel card will fall if the battery runs out. Lightly hold the pixel card with your hand to prevent it from falling.

- (1) Push the maintenance tool against the pixel card without turning it on.
- (2) Turn the maintenance tool on and then install the pixel card to the cabinet paying attention that the arrows on the back of the pixel card and on the hub board are orientated toward the same direction, and that the two guide pins of the pixel card are aligned to the guide holes of the cabinet (two for each pixel card).

The pixel card is secured by the 14 magnets on each cabinet.

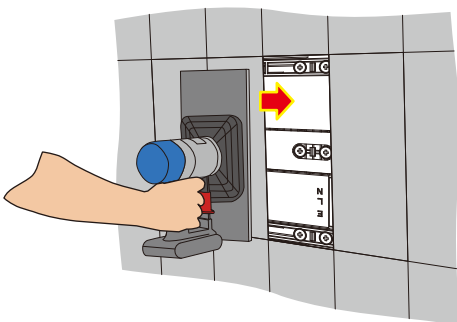

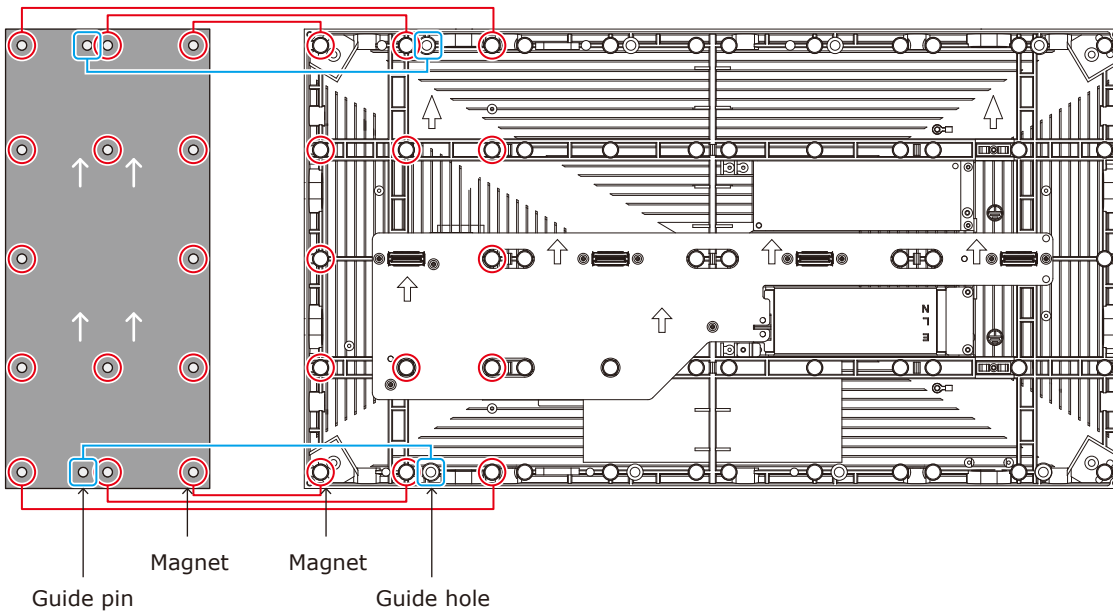

(3) Check that the pixel card stays securely in place and then turn the maintenance tool off.

# Screen Configuration

Check that all the connections are completed, and then turn on the LED modules and the LED controller.

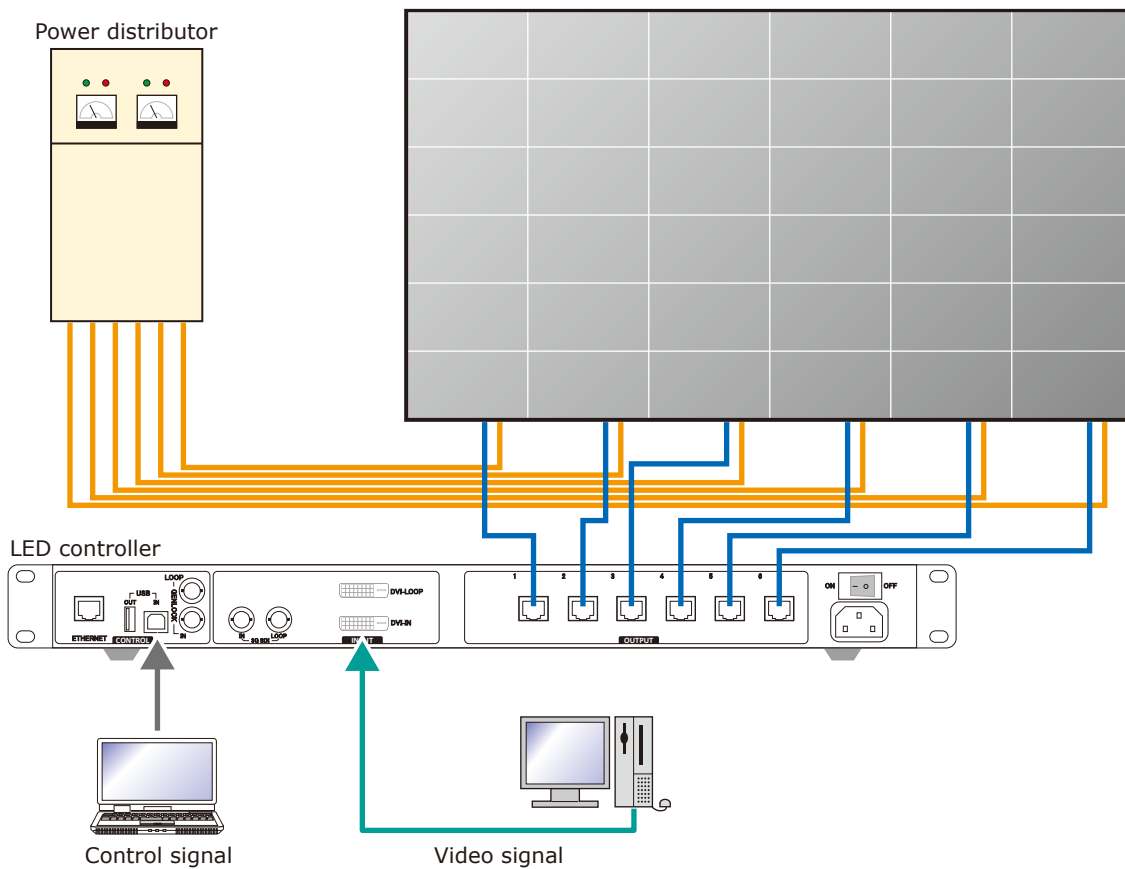

## **⚠ WARNING**

Pay attention to the wire colors of the power cord when connecting the cord. If the cables are not connected correctly, it may lead to a fire or an electrical shock.

- Blue (N)
- Brown (L)
- Yellow green (Ground)

## **⚠ CAUTION**

When using LAN cables of 60 m to 100 m in length, the product may not operate correctly depending on the quality of the cables. In such a case, it is recommended to use optical-fiber cables. Ask a technician or your retailer for more details.

## Setting the screen configuration

Perform the setting using the LCT-Mars control software by Novastar.

Log in with the administrator privileges.

Display the login screen as follows: User(U) → Advanced Synchronous System UserLogin(A).

Enter the password ("admin" by default) to log in with the administrator privileges.

To change the password, go to User(U) → Change Password(U) with the administrator privileges.

### CAUTION

Do not forget the new password after it has been changed.

Click "Screen Configuration" (a).

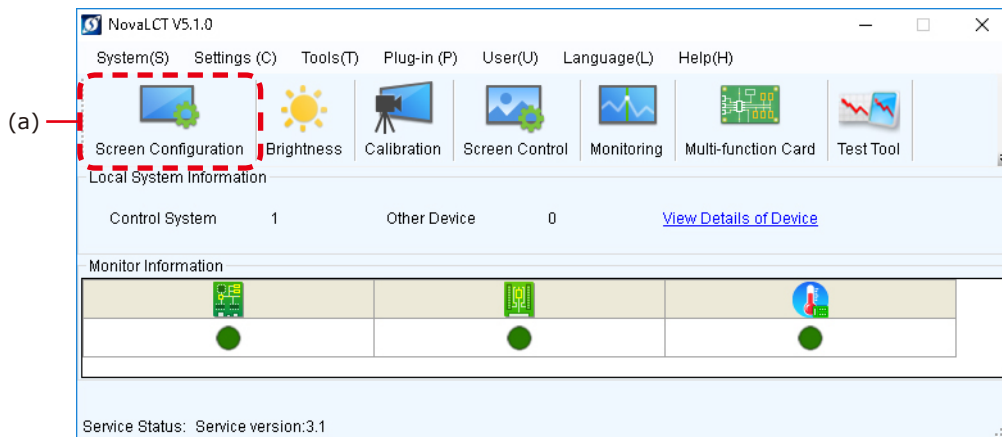

Check the port in "Select Communication Port", and then click the "Next" button (b).

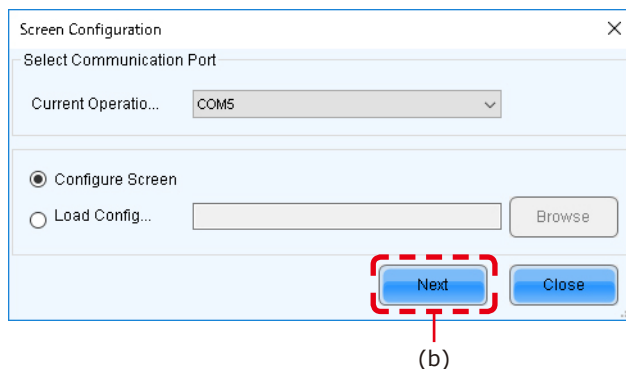

In the Screen Configuration screen that is displayed, select the "Screen Connection" tab (c).

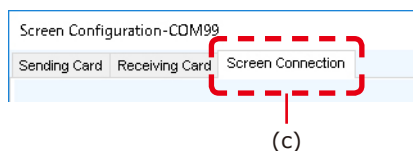

### CAUTION

Do not change the settings in the "Receiving Card" tab. Otherwise, the video may not be displayed properly.

Select "Standard Screen" under "Screen Type" (d).

The settings in "Sending Card Number" (e) and "Ethernet Port No." (f) vary depending on the connected LED controller.

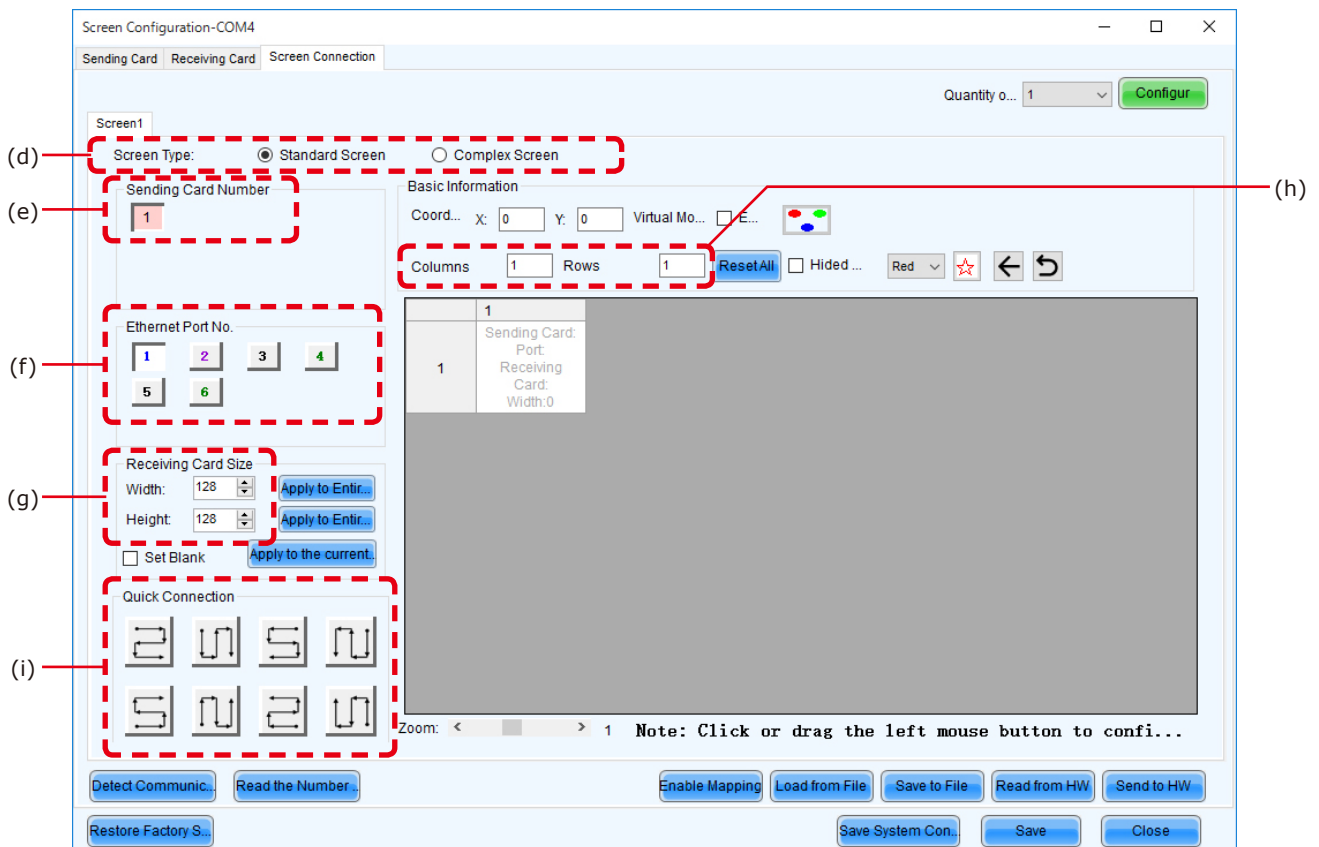

Enter the value in the table below under "Receiving Card Size" (g).

Product name	LED-E012i	LED-E015i	LED-E018i	LED-E025i
Pixel pitch	1.25 mm	1.56 mm	1.88 mm	2.50 mm
Number of displayed pixels (resolution/module)	Width 480 Height 270	Width 384 Height 216	Width 320 Height 180	Width 240 Height 135

[Columns/Rows] Enter the number of installed screens under "Columns/Rows" (h) (the number of vertically installed screens in Columns, and the number of horizontally installed screens in Rows).

[Configuration example]

The setting values are given for the following example where 16 LED-E012i modules (pixel pitch of 1.25 mm) are installed in a 4 (columns) x 4 (rows) configuration.

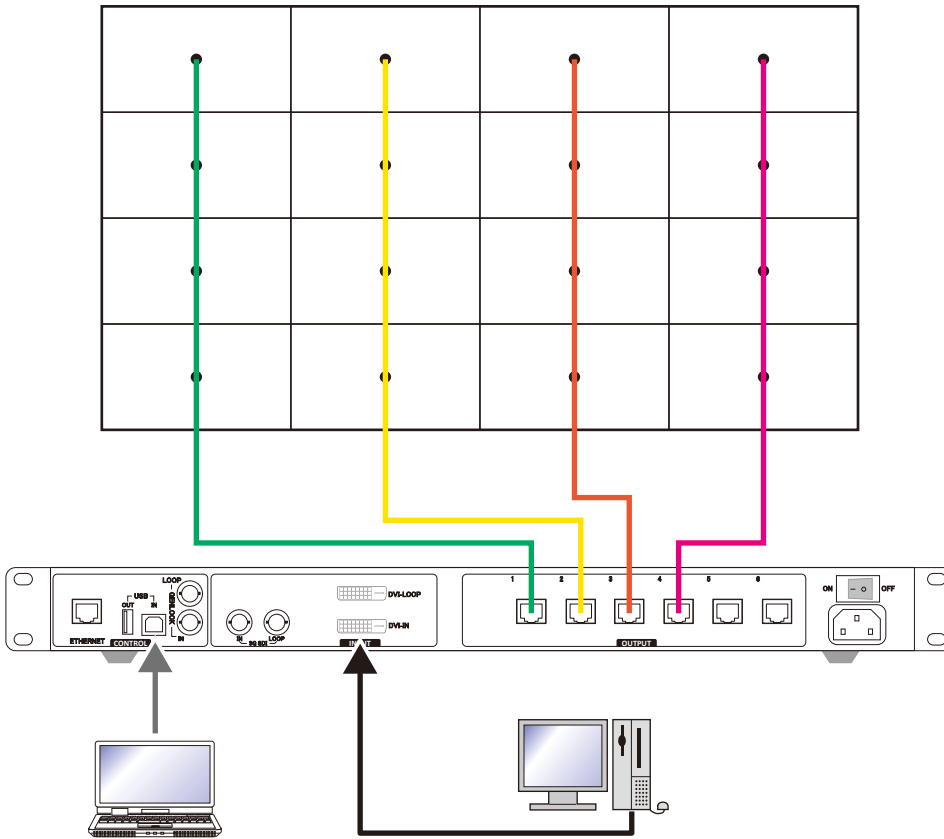

- (1) With a pixel pitch of 1.25 mm, enter Width=480 and Height=270 under "Receiver Card Size" (g). Do not use the buttons located next to the values.

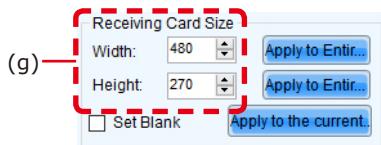

- (2) Since the configuration is 4 (columns) x 4 (rows), enter Columns=4 and Rows=4. A 4 (columns) x 4 (rows) screen configuration is displayed.

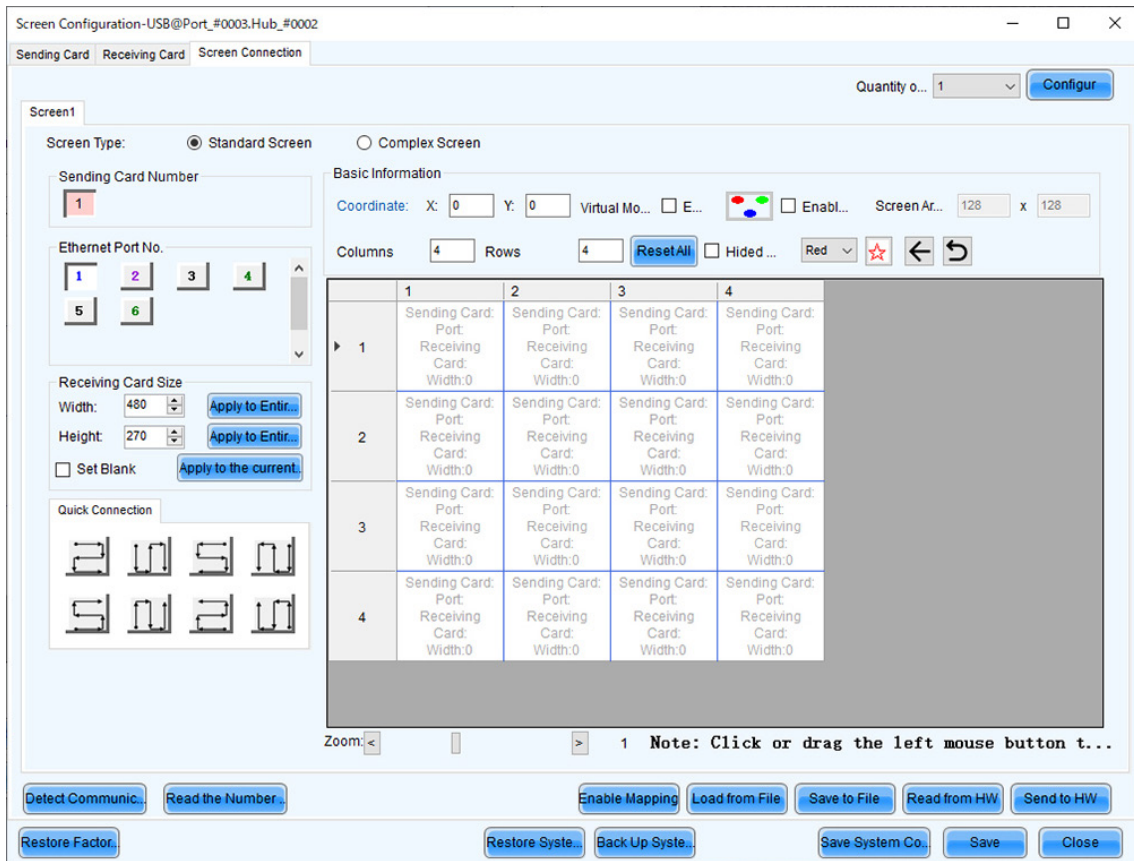



(3) If multiple LED controllers are used, select the number of the connected LED controllers.  
 Since only one controller is used in this example, it is not necessary to set "Sending Card Number" (e).

(4) Configure the connection.

(4)-1 Connecting from bottom to top using multiple ports

The system is connected to port 1 of the LED controller.

Select "1" (port 1) under "Ethernet Port No." (f).

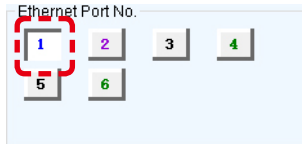

Select the cabinet at the bottom left with the mouse, and then select the other cabinets up to the top cabinet.

Then select Port2 and select the cabinets from the bottom to the top as you did for Port1.

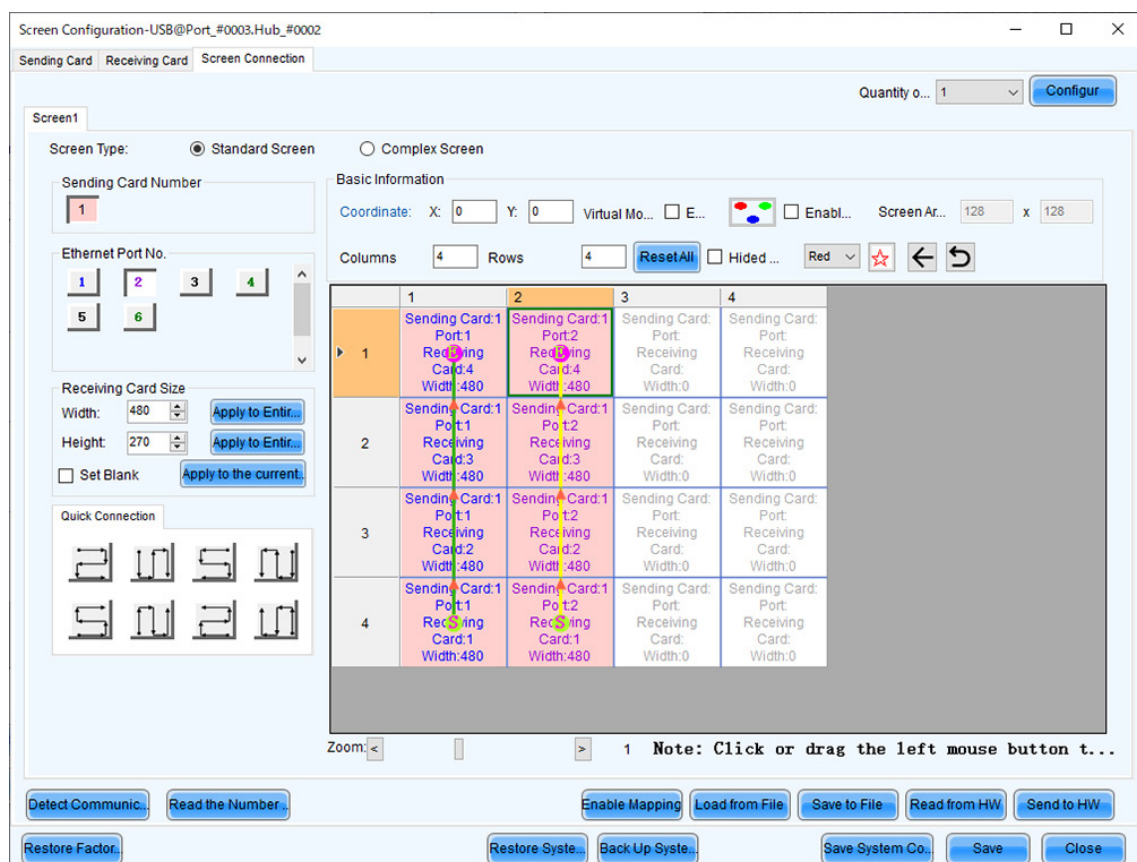

Follow the same procedure for Port3 and Port4.

Screen Configuration-USB@Port\_#0003.Hub\_#0002

Sending Card Receiving Card Screen Connection

Quantity o... 1 **Configur...**

Screen1

Screen Type:  Standard Screen  Complex Screen

Sending Card Number: 1

Ethernet Port No.: 1, 2, 3, 4, 5, 6

Receiving Card Size: Width: 480, Height: 270

Quick Connection: [Icons]

Basic Information: Coordinate: X: 0 Y: 0 Virtual Mo... E... Enabl... Screen Ar... 128 x 128

Columns: 4 Rows: 4 **ResetAll**  Hided... Red  ☆ ← ↻

	1	2	3	4
1	Sending Card:1 Port:1 Receiving Card:4 Width:480	Sending Card:1 Port:2 Receiving Card:4 Width:480	Sending Card:1 Port:3 Receiving Card:4 Width:480	Sending Card:1 Port:4 Receiving Card:4 Width:480
2	Sending Card:1 Port:1 Receiving Card:3 Width:480	Sending Card:1 Port:2 Receiving Card:3 Width:480	Sending Card:1 Port:3 Receiving Card:3 Width:480	Sending Card:1 Port:4 Receiving Card:3 Width:480
3	Sending Card:1 Port:1 Receiving Card:2 Width:480	Sending Card:1 Port:2 Receiving Card:2 Width:480	Sending Card:1 Port:3 Receiving Card:2 Width:480	Sending Card:1 Port:4 Receiving Card:2 Width:480
4	Sending Card:1 Port:1 Receiving Card:1 Width:480	Sending Card:1 Port:2 Receiving Card:1 Width:480	Sending Card:1 Port:3 Receiving Card:1 Width:480	Sending Card:1 Port:4 Receiving Card:1 Width:480

Zoom: < | > 1 **Note: Click or drag the left mouse button t...**

**Detect Communic...** **Read the Number...** **Enable Mapping** **Load from File** **Save to File** **Read from HW** **Send to HW** (j)

**Restore Factor...** **Restore System...** **Back Up System...** **Save System Co...** **Save** (k) **Close** (l)

(4)-2 Connecting all the LED modules using a single LAN cable

The system is connected to port 1 of the LED controller.

Select "1" (port 1) under "Ethernet Port No." (f).

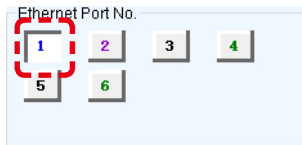

Click (select) the connection pattern under "Quick Connection" (i). Since the modules are connected from the bottom left to the top right in the example, the pattern is as shown in the figure.

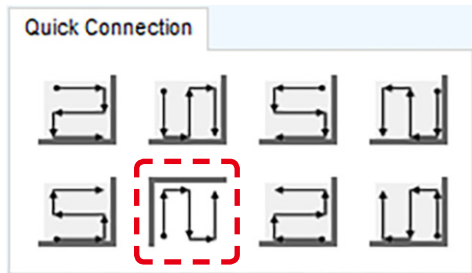

Select all the cabinets from the top left to the bottom right as shown in the figure below.

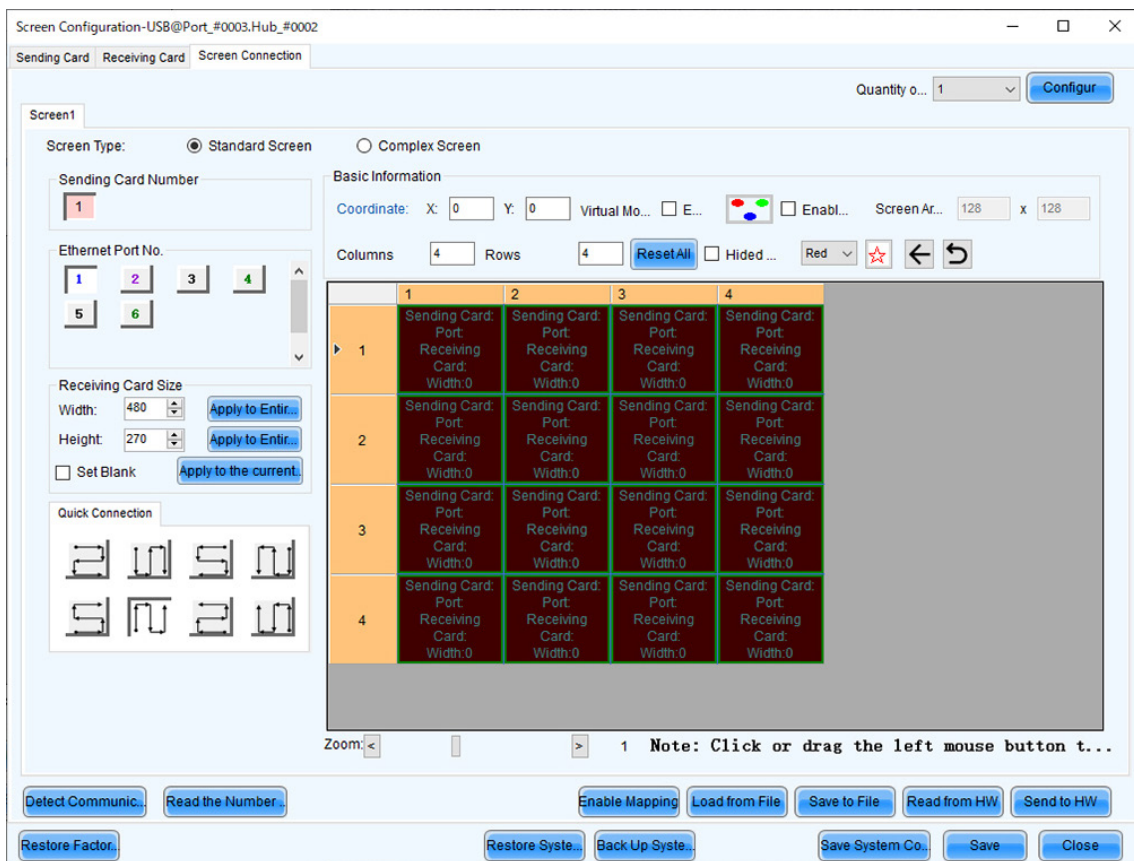

The selection is done automatically to obtain the screen below.

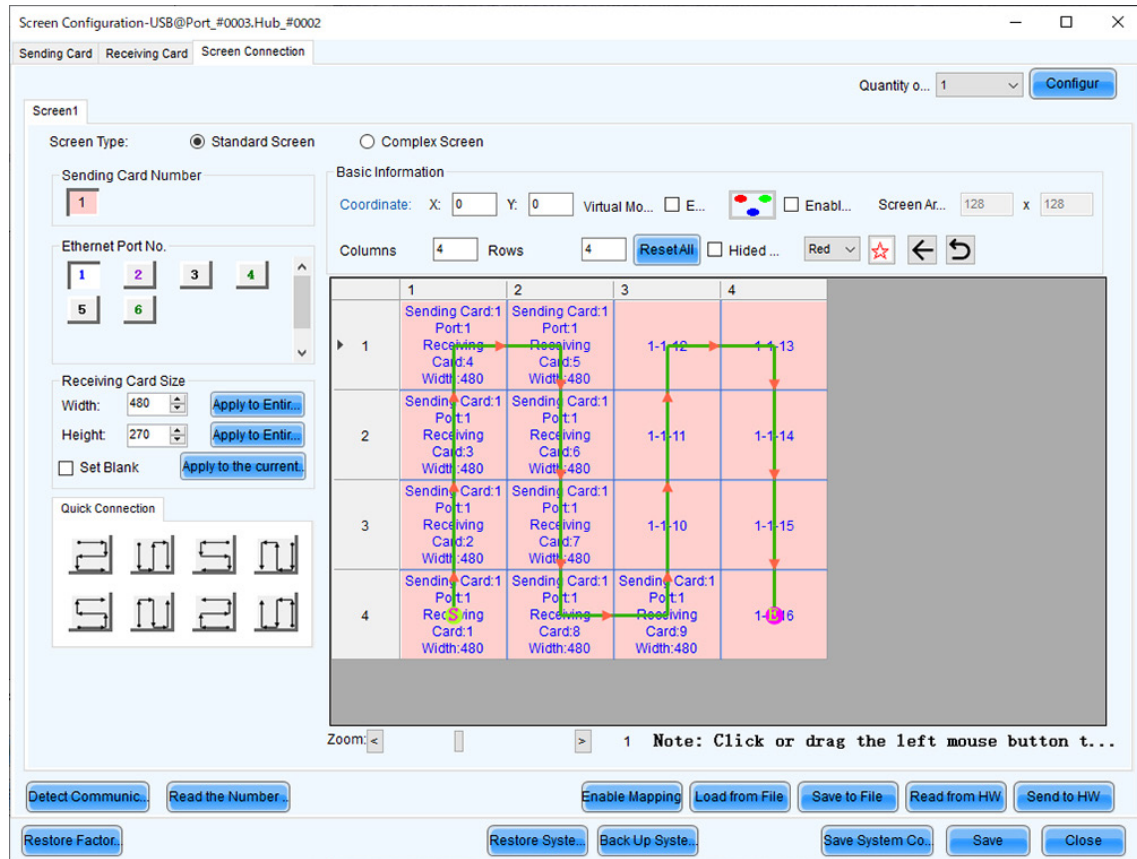

(5) Save the settings.

- (a) Click the "Send to HW" button (j). When the dialog box indicating that the process finished successfully is displayed, click OK.
- (b) Check that the image is correctly displayed, and then click the "Save" button (k). When the screen indicating that the process finished successfully is displayed, click OK.

The setting of the screen configuration is complete. Click the "Close" button (l) to close the Screen Configuration screen.

# Image Setting

You can adjust the brightness, the gamma correction value, and the color temperature.

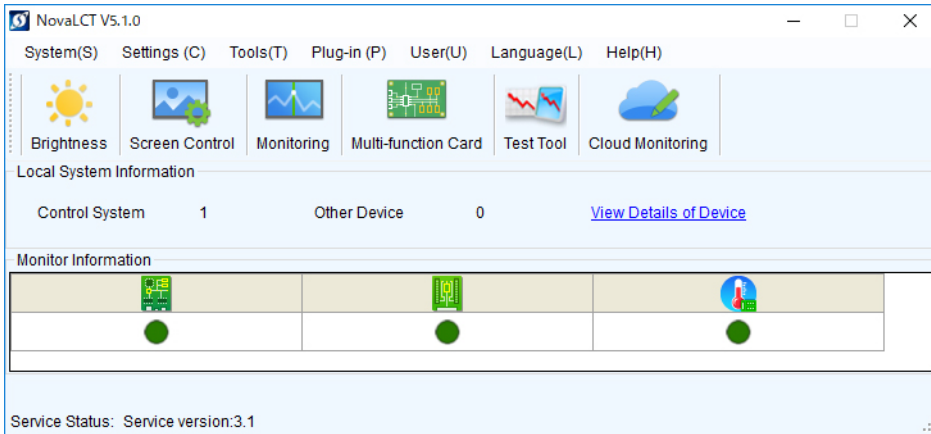

Click "Brightness" on the top screen to display the following window.

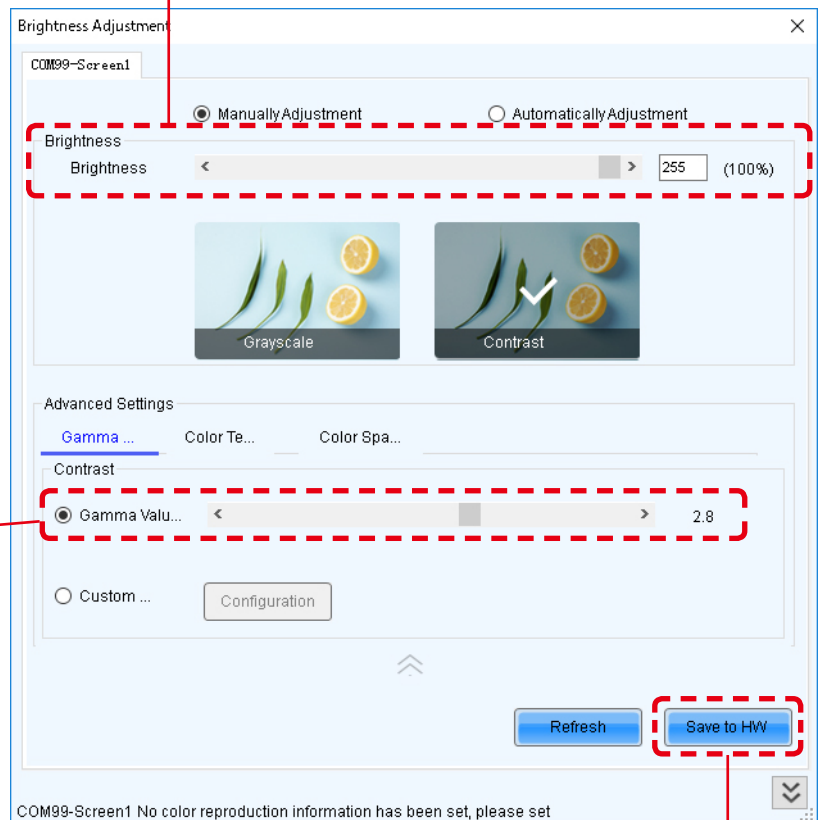
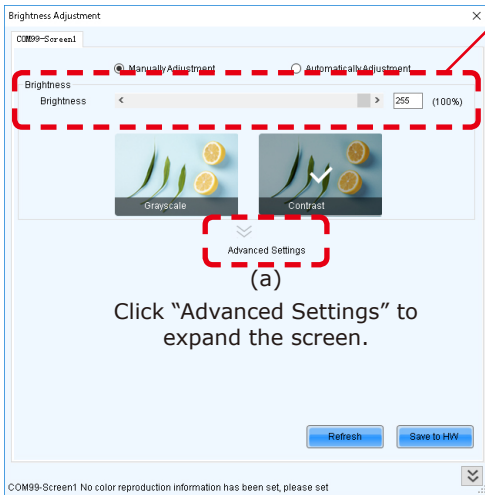

Click "Advanced Settings" (☑) (a) to expand the setting screen.

(1) Brightness

Set the brightness of the screen using the slider (b).  
Increasing the value increases the brightness.

(2) Gamma correction

Set the gamma correction value using the slider (c).  
Increasing the value makes the dark parts of the screen darker.

(3) Color temperature

Set the color temperature using the slider (d).  
Increasing the value makes the colors more bluish, while reducing the value makes the colors more reddish.  
When the setting is complete, click the "Save to HW" button to save the settings.

# Maintenance

## CAUTION

- Disconnect the power supply to the LED modules when performing the maintenance.
- Use the correct screwdriver for the shape of the screws when removing (loosening) or setting (tightening) the screws.  
Pay attention not to drop the screws and the other parts you have removed.  
Pay attention not to lose the removed screws since they will be reused.

## Removing a pixel card

Remove the pixel card using the maintenance tool.

Pull the trigger of the handle to activate the suction function. Release the trigger to stop the suction function.

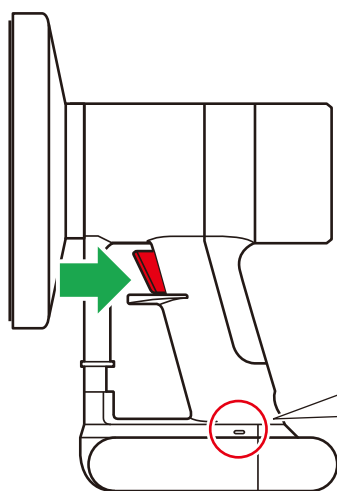

### Status display

- Lit blue: In operation
- Flashing blue: Battery is low.  
Charge the tool using the AC adapter supplied with the maintenance tool.

## CAUTION:

Check that the battery of the maintenance tool is fully charged before starting the work. Pixel card falls if the battery runs out. Hold the pixel card with your hand to support in case it falls.

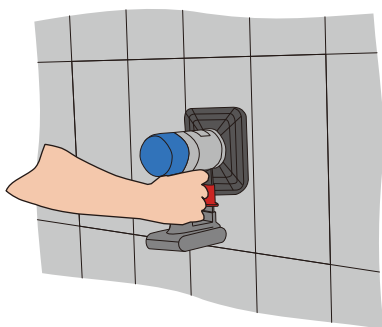

(1) Push the maintenance tool against the pixel card without turning it on.

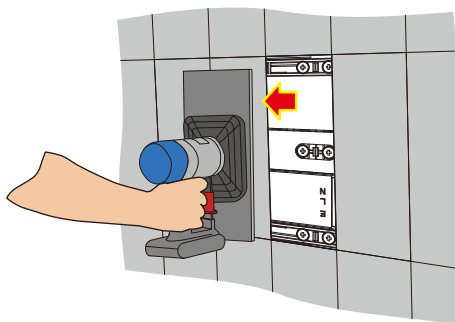

(2) Turn the maintenance tool on, and then pull it straight toward you to remove the pixel card. Keep the maintenance tool turned on.  
(3) Hold the pixel card, and then turn the maintenance tool off.

## CAUTION:

Do not turn the maintenance tool off until you hold the pixel card. Otherwise, the pixel card may fall and break.

## Removing the power supply

Disconnect the LAN cable connected to the hub board.

Remove the 10 screws securing the hub board, and then remove the hub board. Then, remove the two screws securing the terminal cover.

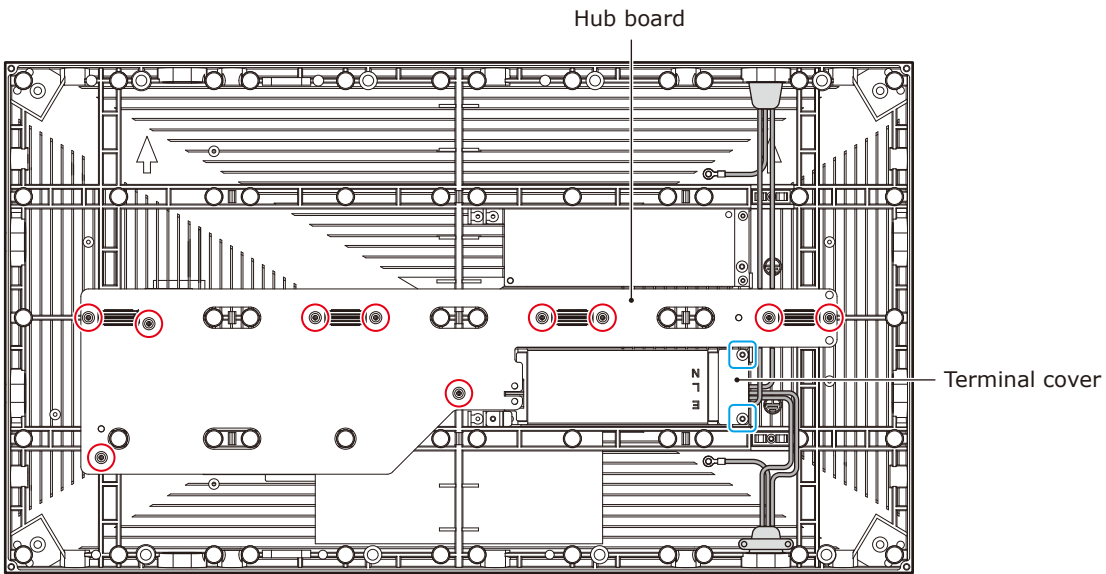

Disconnect the power cables connected to the power supply and remove the two screws securing the power supply, and then remove the power supply.

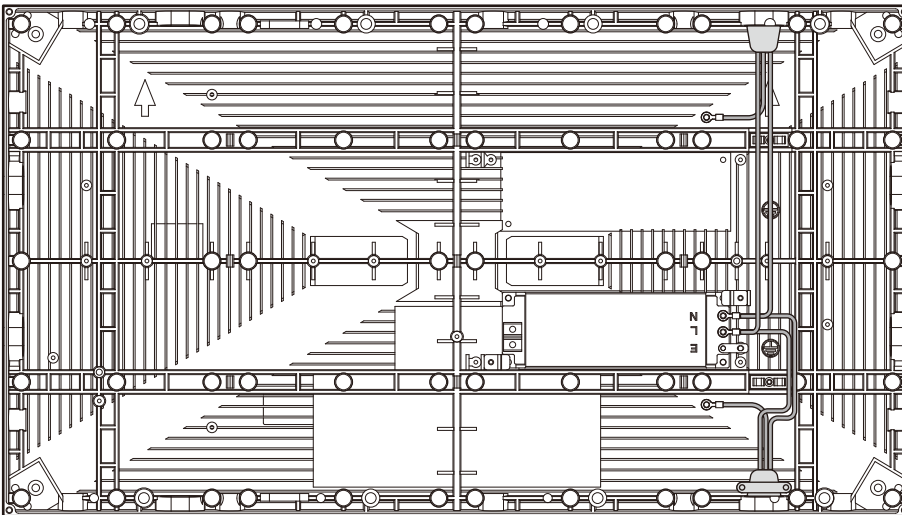

The power supply installation is done by following the same procedure in the reverse order.

### **⚠ CAUTION:**

When attaching two cables with one screw, place the ring terminals of the cables back to back.

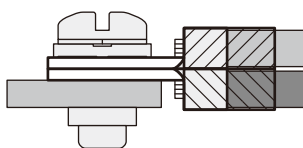

**OK**

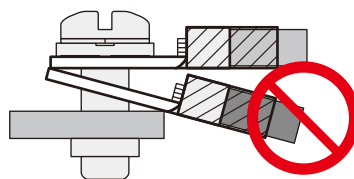

**NG**



## Removing the receiving card

Remove the receiving card from the hub board.

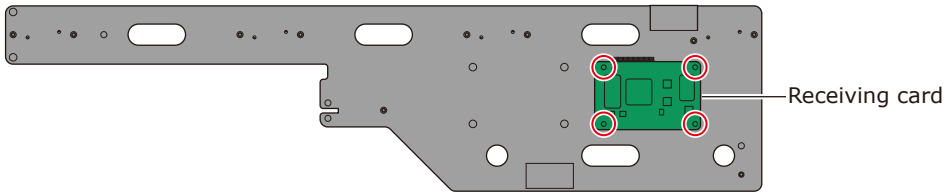

# Troubleshooting

## 1. Display problems

Problem	Solution
Nothing is displayed on all the LED modules.	Check that power is being supplied to the LED modules.
	Check that the LED controller is turned on.
	Check that a video signal is being input to the LED controller.
	Check that a LAN cable is correctly connected between the LED controller and the LED module.
	Check that the brightness is not set to 0% (= not lit).
Nothing is displayed on one LED module.	Check that a LAN cable is correctly connected between the LED controller and the LED module.
	The receiving card inside the LED module may be broken. → Check the status of the LED module by following the procedure in the next section "2 State monitoring using the software".
	The power unit inside the LED module may be broken. → Check the status of the LED module by following the procedure in the next section "2 State monitoring using the software".
No image is displayed on one pixel card.	Check that the contacts of the pixel card are correct (contacts of the hub board).
	The pixel card may be broken. Replace it with a spare pixel card.
Control (communication) is not possible.	Check that the communication cable is correctly connected between the computer and the LED controller.
	Check that the LED controller is turned on.
	If the communication cable is a USB cable, check that the device driver runs correctly.

## 2. State monitoring using the software

In case of a problem, you will be able to determine the location where it occurred by monitoring the state of the system.

### 2-1 Display under normal conditions

The display is green under normal conditions.

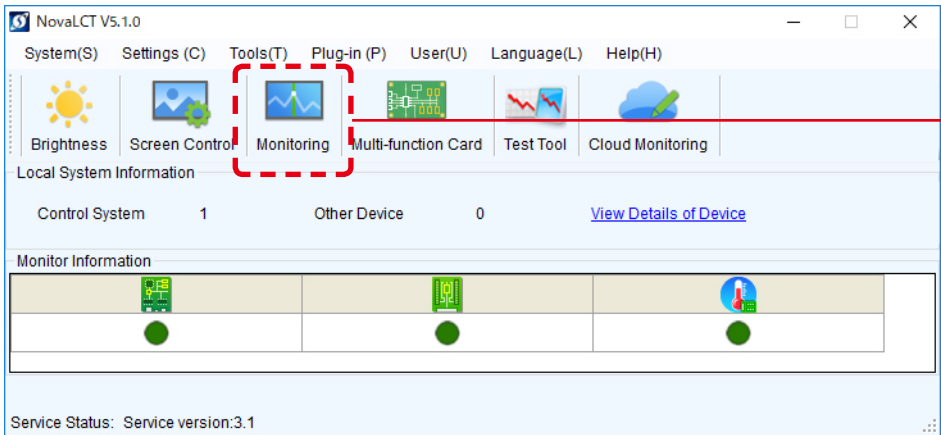

Click "Monitoring" to check

- the state of the LED controller
- the operating state of the LED modules
- the temperature of the LED modules

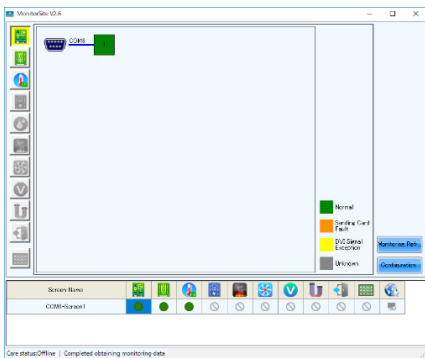

State of the LED controller

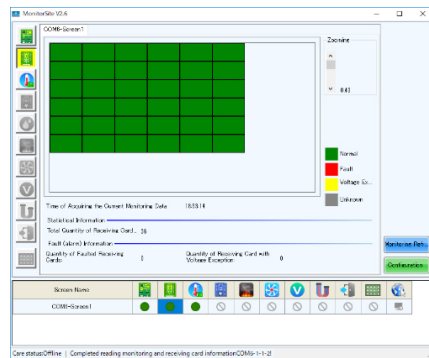

State of the LED modules

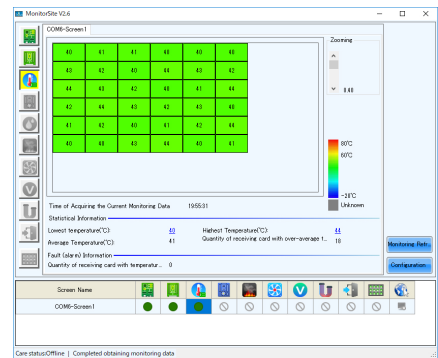

Temperature of the LED modules

## 2-2 Display under abnormal conditions

### (1) Problem with the input signal to the LED controller

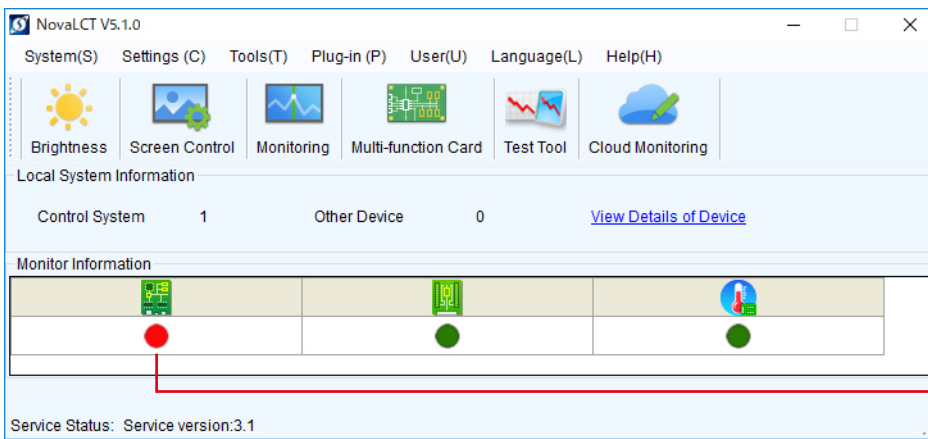

When the display is red, there is a problem with the LED controller.

To display more details, click "Monitoring", and then click "Sending card" on the screen that is displayed.

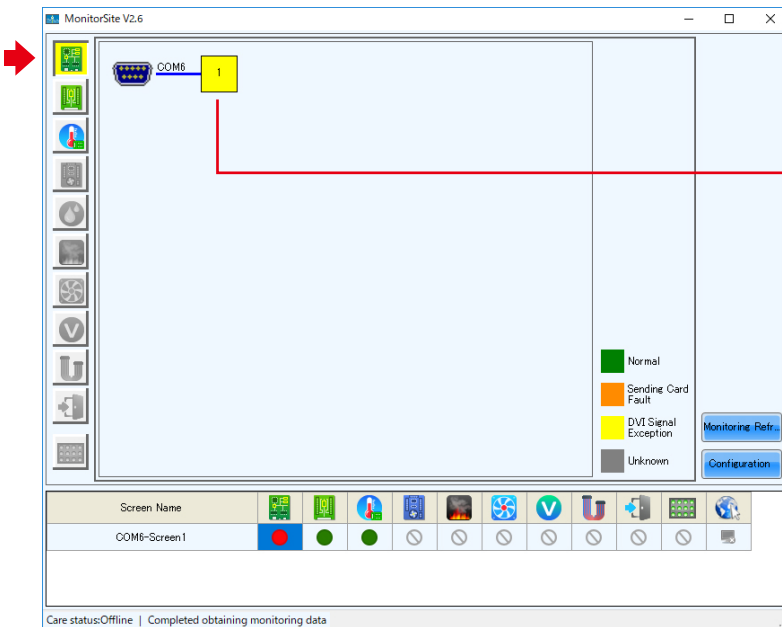

No video signal is being input to the LED controller.

- Check that the LAN cable is connected.
- Check that a video signal is being output from the video output equipment.
- If multiple signals are being input to the LED controller, check the input settings of the LED controller.

(2) Problem with the LED modules

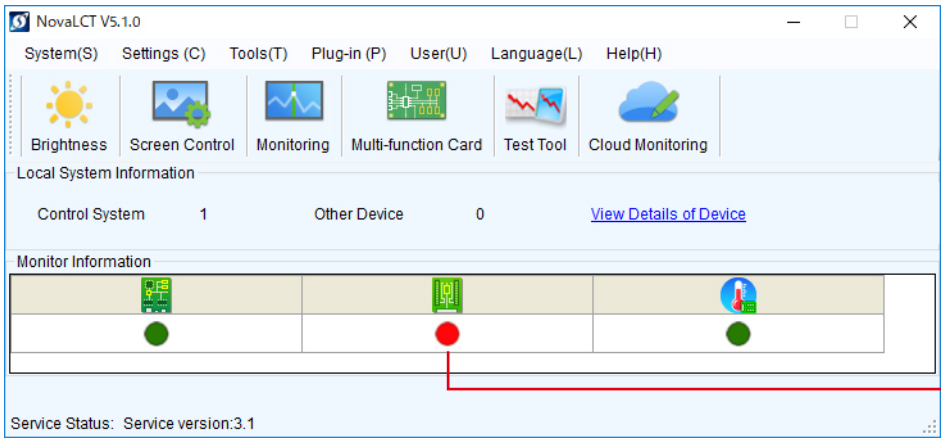

When the display is red, there is a problem with the LED module operation.

To display more details, click "Monitoring", and then click "Receiving card" on the screen that is displayed.

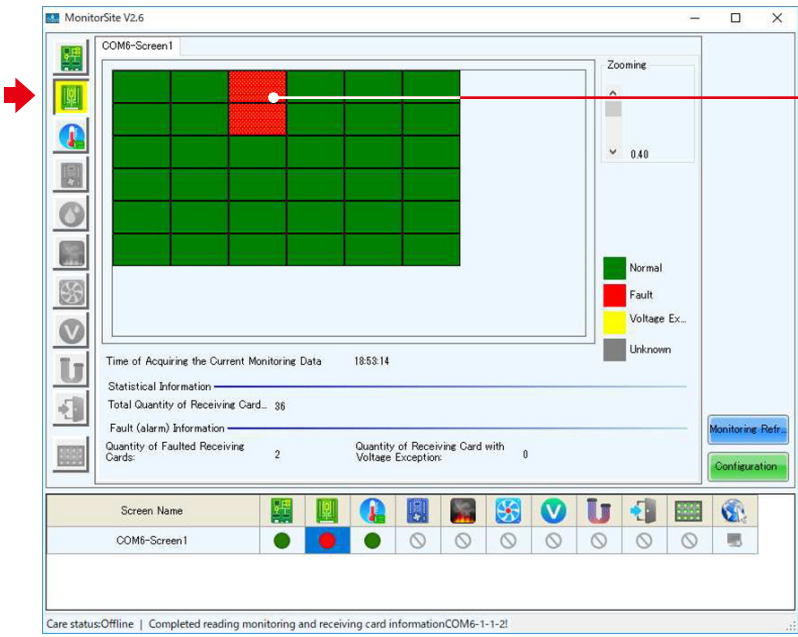

In the example shown on the left, the following problems must be considered.

- Signal loss between the screen of the 1st row 3rd column and the screen of the 1st row 2nd column
  - Check the LAN cable.
- Problem with the power unit of the screen of the 1st row 2nd column
  - Check the LAN cable.
- Problem with the receiving card of the screen of the 1st row 2nd column.
  - Check that the receiving card is securely connected.

With the connection shown in the figure below.

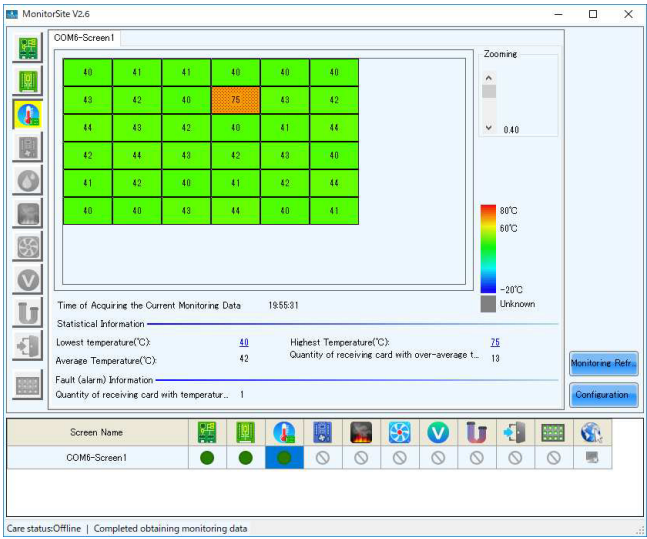

(3) Problem with the internal temperature of the LED modules

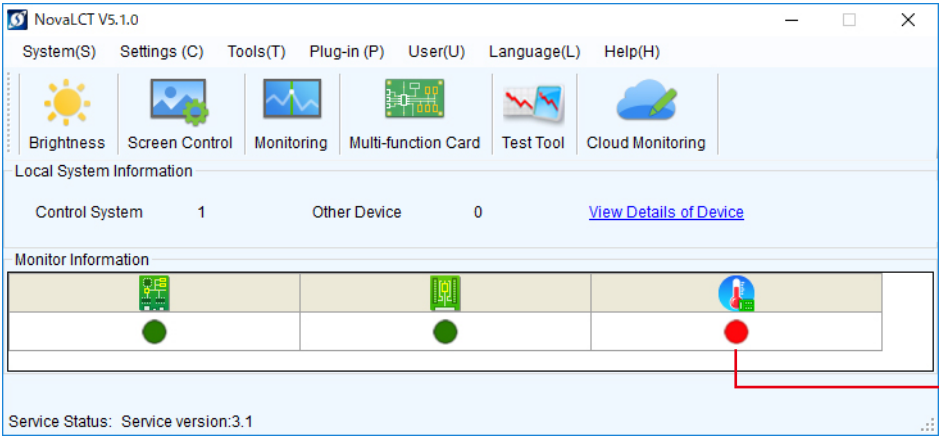

There is a problem with the LED module operation.

To display more details, click "Monitoring", and then click "Temperature" on the screen that is displayed.

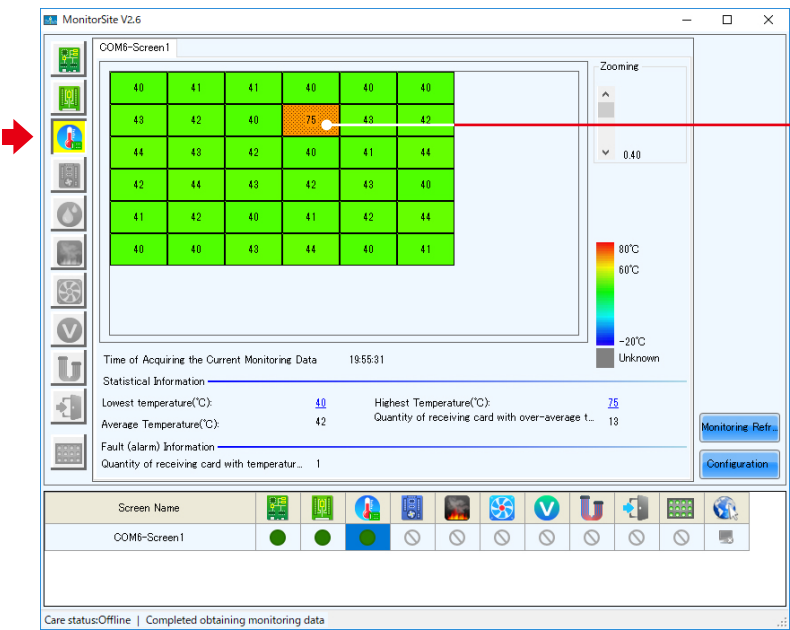

The LED modules with a high temperature are displayed in warm colors. Since the internal temperature is high, decrease the brightness setting. If changing the brightness setting could not solve the problem, contact your retailer or the Customer Service.

#### (4) Communication problem

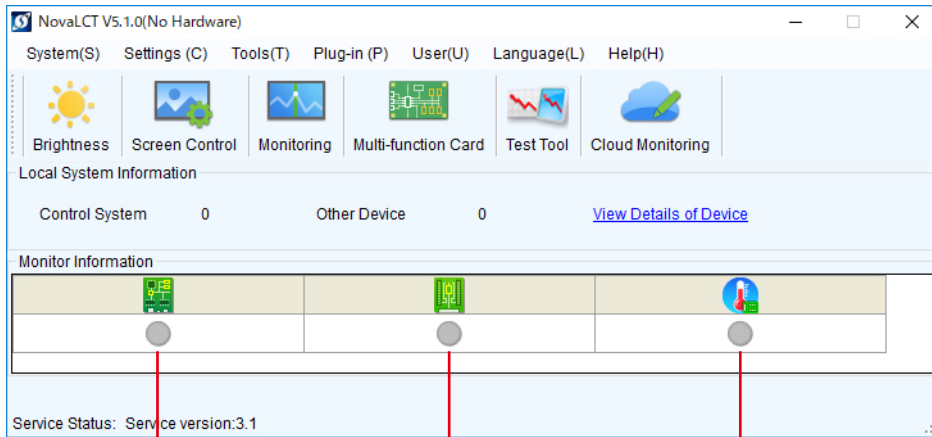

When the display is grey, the communication is not established.  
→ Check that the USB cable is connected.  
→ Check that the LED controller is turned on.

# Specifications

## Models for indoor use

		LED-E012i	LED-E015i	LED-E018i	LED-E025i
LED configuration		3-in-1 SMD			
Pixel pitch		1.25 mm	1.56 mm	1.88 mm	2.50 mm
Number of displayed pixels (resolution/module)		480 × 270	384 × 216	320 × 180	240 × 135
Brightness		600 cd/m <sup>2</sup>	600 cd/m <sup>2</sup>	800 cd/m <sup>2</sup>	800 cd/m <sup>2</sup>
Contrast ratio		5000:1	5000:1	7000:1	7000:1
Brightness adjustment range		0 to 100% (256 increments)			
Gamma correction		1.0 to 4.0 (default setting: 2.8)			
Color temperature		3000 K to 9500 K (default setting: 6500 K)			
Viewing angle		Horizontally 85°/ Vertically 80°	Horizontally 80°/ Vertically 70°	Horizontally 80°/ Vertically 70°	Horizontally 80°/ Vertically 70°
Signal interface	Signal input	1 × RJ-45			
	Signal output	1 × RJ-45			
Power supply		100 V AC to 240 V AC, 50 Hz/60 Hz			
Power consumption (all white, 100% brightness)		125 W			
Ingress protection		Front IP 20 / Back IP 20			
Maintenance		Front			
Dimensions		600 × 337.5 × 29 mm			
Weight		4.7 kg			
Operating environment	Temperature	-20 to 40°C			
	Humidity	10% to 80% (without condensation)			
	Altitude	No more than 5000 m			
Storage environment	Temperature	-20 to 45°C			
	Humidity	10% to 85% (without condensation)			

Specifications are subject to change without notice.



# Diagram

LED-E012i / LED-E015i / LED-E018i / LED-E025i

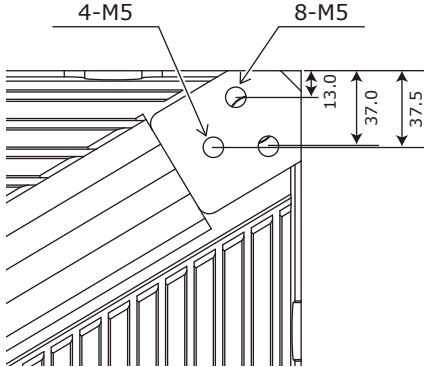
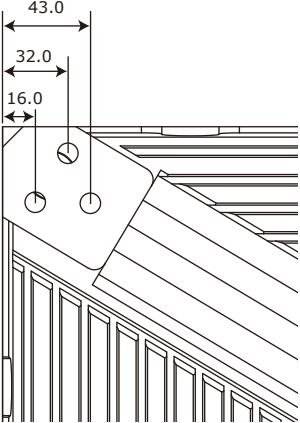
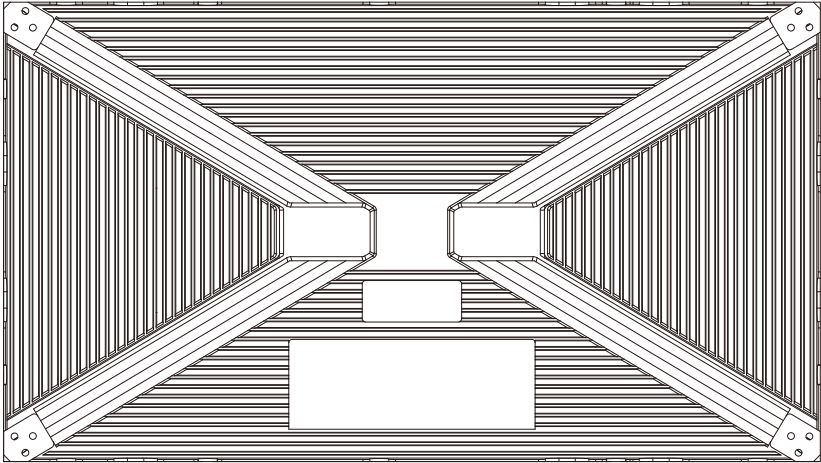
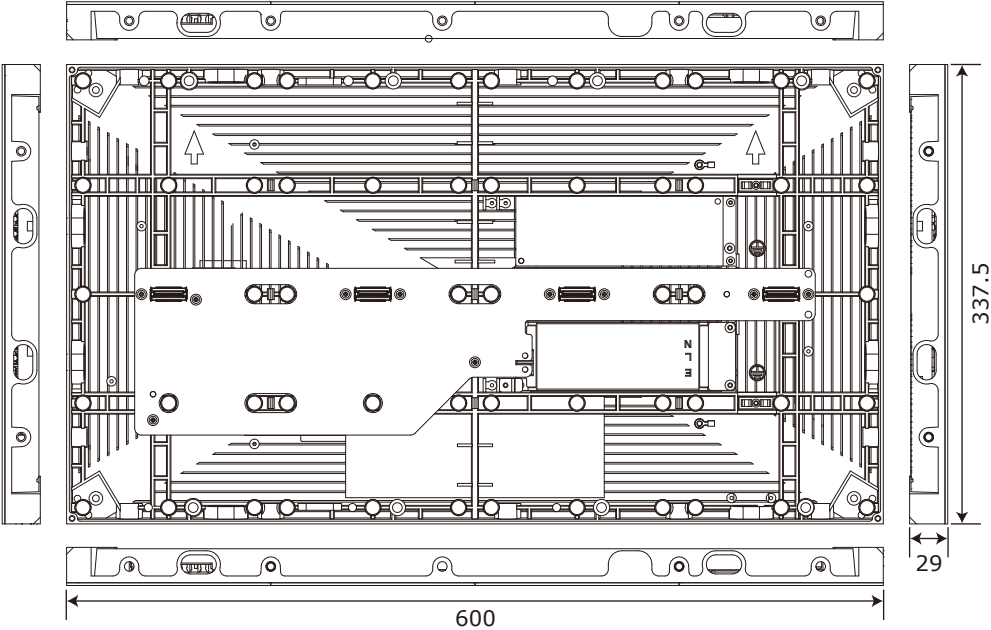

(Unit: mm)

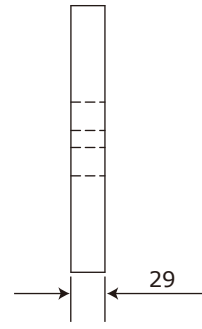
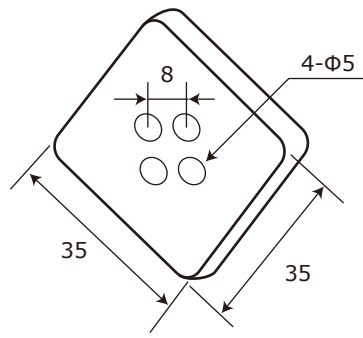

(Unit: mm)

## WEEE Mark (European Directive 2012/19/EU and amendments)



### Disposing of your used product: In the European Union

EU-wide legislation as implemented in each Member State requires that used electrical and electronic products carrying the mark (left) must be disposed of separately from normal household waste. This includes LED Poster and electrical accessories, such as signal cables or power cords. When you dispose of such products, please follow the guidance of your local authority or ask the shop where you purchased the product, or if applicable, follow applicable legislation or agreement you may have. The mark on electrical and electronic products may only apply to the current European Union Member States.

### Outside the European Union

If you wish to dispose of used electrical and electronic products outside the European Union, please contact your local authority and ask for the correct method of disposal.



**For EU:** The crossed-out wheeled bin implies that used batteries should not be put to the general household waste! There is a separate collection system for used batteries, to allow proper treatment and recycling in accordance with legislation.

**According to EU directive 2006/66/EC and amendments, the battery can't be disposed improperly. The battery shall be separated to collect by local service.**

## Service & Support in Europe

---

Please contact:

Sharp NEC Display Solutions Europe GmbH.  
Landshuter Allee 12-14, D-80637 München  
Phone: + 49 (0) 89/99699-0  
Fax: + 49 (0) 89/99699-500

For the latest information please see

<https://www.sharpnecdisplays.eu>

Data is subject to change without notice.

## Sales Office List for Asia/Pacific

---

For the latest information please see

<https://www.sharp-nec-displays.com/ap/contact/index.html>